

Digital Power Meter

GPM-8213

USER MANUAL



ISO-9001 CERTIFIED MANUFACTURER

GW INSTEK

This manual contains proprietary information, which is protected by copyright. All rights are reserved. No part of this manual may be photocopied, reproduced or translated to another language without prior written consent of Good Will company.

The information in this manual was correct at the time of printing. However, Good Will continues to improve products and reserves the rights to change specification, equipment, and maintenance procedures at any time without notice.

Good Will Instrument Co., Ltd.
No. 7-1, Jhongsing Rd., Tucheng Dist., New Taipei City 236, Taiwan.

Table of Contents

SAFETY INSTRUCTIONS	5
GETTING STARTED	11
Characteristics	12
Appearance	15
Set Up.....	26
BASIC SETTING	29
Setting up measurement range	30
Setting up measurement status	34
Setting up System status	42
MEASUREMENT AND OTHER FUNCTIONS	47
Measurement function	48
Other functions	51
Integration measurement function.....	53
REMOTE CONTROL	60
Configure Remote Control Interface	61
Return to Local Control.....	62
COMMAND OVERVIEW	65
Command Syntax	65
Command List	69
APPENDIX	102
Specifications	103
Dimensions	108
Declaration of Conformity.....	109
Power measurement	110
Introduction to IEC-62301	112

EUP Directive Lot6 specifications 112
Connection Guide 113

S SAFETY INSTRUCTIONS

This chapter contains important safety instructions that you must follow during operation and storage. Read the following before any operation to ensure your safety and to keep the instrument in the best possible condition.

Safety Symbols

These safety symbols may appear in this manual or on the instrument.



WARNING

Warning: Identifies conditions or practices that could result in injury or loss of life.



CAUTION

Caution: Identifies conditions or practices that could result in damage to the GPM-8213 or to other properties.



DANGER High Voltage



Attention Refer to the Manual



Protective Conductor Terminal



Earth (ground) Terminal



Do not dispose electronic equipment as unsorted municipal waste. Please use a separate collection facility or contact the supplier from which this instrument was purchased.

Safety Guidelines

General Guideline • Make sure that the voltage input level does not exceed DC848V/AC600V.



CAUTION

- Make sure the current input level does not exceed 20A.
- Do not place any heavy object on the instrument.
- Avoid severe impact or rough handling that can lead to damaging the instrument.
- Do not discharge static electricity to the instrument.
- Use only mating connectors, not bare wires, for the terminals.
- Do not block or obstruct the cooling fan vent opening.
- Do not perform measurement at the source of a low-voltage installation or at building installations (Note below).
- Do not disassemble the instrument unless you are qualified as service personnel.
- Make sure that the COM terminal to earth is limited to 300Vpk.
- Remove all test leads before disconnecting the mains power cord from the socket.
- If the equipment is used in a manner not specified by the manufacturer, the protection provided by the equipment may be impaired.
- The device should be placed in a place where the plug connected to it can be removed easily.

(Note) EN 61010-1:2010 specifies the measurement categories and their requirements as follows. The GPM-8213 falls under category II 300V.

- Measurement category IV is for measurement performed at the source of low-voltage installation.
- Measurement category III is for measurement performed in the building installation.
- Measurement category II is for measurement performed on the circuits directly connected to the low voltage installation.

Power Supply



WARNING

- AC Input voltage: 100-240 VAC 50/60Hz
- The power supply voltage should not fluctuate more than 10%.
- Connect the protective grounding conductor of the AC power cord to an earth ground, to avoid electrical shock.

Cleaning the Instrument

- Disconnect the power cord before cleaning.
- Use a soft cloth dampened in a solution of mild detergent and water. Do not spray any liquid.
- Do not use chemicals containing harsh material such as benzene, toluene, xylene, and acetone.

Operation Environment

- Location: Indoor, no direct sunlight, dust free, almost non-conductive pollution (Note below)
- Temperature: 0°C to 40°C
- Humidity: < 30°C: < 80%RH(non-condensing);
30°C~40°C:<70%RH(non-condensing);
>40°C: <50%RH (non-condensing)
- Altitude: <2000m

(Note) EN 61010-1:2010 specifies the pollution degrees and their requirements as follows. The GPM-8213 falls under degree 2.

- Pollution refers to “addition of foreign matter, solid, liquid, or gaseous (ionized gases), that may produce a reduction of dielectric strength or surface resistivity”.
- Pollution degree 1: No pollution or only dry, non-conductive pollution occurs. The pollution has no influence.
- Pollution degree 2: Normally only non-conductive pollution occurs. Occasionally, however, a temporary conductivity caused by condensation must be expected.
- Pollution degree 3: Conductive pollution occurs, or dry, non-conductive pollution occurs which becomes conductive due to condensation which is expected. In such conditions, equipment is normally protected against exposure to direct sunlight, precipitation, and full wind pressure, but neither temperature nor humidity is controlled.

Storage environment

- Location: Indoor
- Temperature: -40°C to 70°C
- Humidity: <90%RH(non-condensing)

Disposal



Do not dispose this instrument as unsorted municipal waste. Please use a separate collection facility or contact the supplier from which this instrument was purchased. Please make sure discarded electrical waste is properly recycled to reduce environmental impact.

Power cord for the United Kingdom

When using the unit in the United Kingdom, make sure the power cord meets the following safety instructions.

NOTE: This lead/appliance must only be wired by competent persons



WARNING: THIS APPLIANCE MUST BE EARTHED

IMPORTANT: The wires in this lead are coloured in accordance with the following code:

Green/ Yellow:	Earth
Blue:	Neutral
Brown:	Live (Phase)



As the colours of the wires in main leads may not correspond with the coloured marking identified in your plug/appliance, proceed as follows:

The wire which is coloured Green & Yellow must be connected to the Earth terminal marked with either the letter E, the earth symbol  or coloured Green/Green & Yellow.

The wire which is coloured Blue must be connected to the terminal which is marked with the letter N or coloured Blue or Black.

The wire which is coloured Brown must be connected to the terminal marked with the letter L or P or coloured Brown or Red.

If in doubt, consult the instructions provided with the equipment or contact the supplier.

This cable/appliance should be protected by a suitably rated and approved HBC mains fuse: refer to the rating information on the equipment and/or user instructions for details. As a guide, a cable of 0.75mm² should be protected by a 3A or 5A fuse. Larger conductors would normally require 13A types, depending on the connection method used.

Any exposed wiring from a cable, plug or connection that is engaged in a live socket is extremely hazardous. If a cable or plug is deemed hazardous, turn off the mains power and remove the cable, any fuses and fuse assemblies. All hazardous wiring must be immediately destroyed and replaced in accordance to the above standard.

G E T T I N G S T A R T E D

This chapter describes the GPM-8213 in a nutshell, including accessories, package contents, its main features and front / rear panel introduction.

Characteristics.....	12
Accessories.....	15
Package Contents.....	16
Appearance.....	17
Front Panel.....	17
Display Overview.....	21
Rear Panel.....	24
Set Up	26
Tilting the Stand.....	26
Power Up.....	27
Connect the wires to the GPM-8213	28

Characteristics

The GPM-8213 is a high-precision, programmable power meter for using in standby measuring the device with low power such as switching power supplies, transformers, power supplies, adapter and other devices. It equips with a color TFT-LCD screen which is very convenient for reading the measurement results. The GPM-8213 has become a reliable power measurement instruments because of its simple operation, excellent performance and automatic measurement interface.



Operation

- Press the buttons on the front panel to easily turn on the GPM-8213 measurement function. All settings and measurements results are displayed on the TFT-LCD screen panel for easy use of each function.
- Standard display mode: 2 main measurement results and 6 secondary measurement results are displayed in this screen.
- Simple display mode: 4 major measurement results are displayed in this screen.

Performance	<ul style="list-style-type: none">• 6 selectable voltage ranges available from 15V to 300V with 0.1% of reading + 0.1% of range.• 12 selectable current ranges available from 5mA to 20A with 0.1% of reading + 0.1% of range.• It can even measure the voltage of abnormal wave of CF 3. The half-range CF is up to 6.• It can even measure the current of abnormal wave of CF 3. The half-range CF is up to 6.• Test terminals in the front panel.• Total harmonic distortion measurement.
Features	<ul style="list-style-type: none">• Full five-digit measurement.• Voltage measurement range: 15V ~ 600V or automatic switching• Current measurement range: 5mA ~ 20A or automatic switching• Maximum accuracy of 0.1% of reading + 0.1% of range• 2 main measurement readings and 6 minor measurement readings are displayed in the screen of standard display mode.• 4 main measurement readings are displayed in the screen of simple display mode.• Added stand-alone display of total harmonic distortion measurement function (13 steps)• Test bandwidth of voltage and current: DC ~ 6kHz.• Added W-h power time integrator function• Selectable boot settings (Previous / Default)
Interface	<ul style="list-style-type: none">• Standard interface: USB / RS232 / LAN• Optional interface: GPIB

Application

- It can be applied to production test such as power supplies, transformers, motors, electrical equipment and other equipment with low standby power.
 - It can be applied to power measurement conforms to IEC 62301
 - It can be applied to assess the power consumption of product design.
-

Accessories

Standard Accessories		
Part number	Description	
82PM-82130Ex1	User Manual CD	
82DM-83421Mx1	Safety Instruction Sheet	
Region dependent	Power Cord	
GTL-209	Test leads: 2x red, 2x black	
Optional Accessories		
Part number	Description	
GPM-001	Test Fixture	
GTL-232	RS232C cable	
GTL-246	USB cable	
GTL-248	GPIB cable	
GRA-422	Rack Adapter Panel (19", 2U)	
Option	Name	Description
	Opt.01	GPIB (Factory installed)

Package Contents

Check the contents before using the instrument.

Opening the box

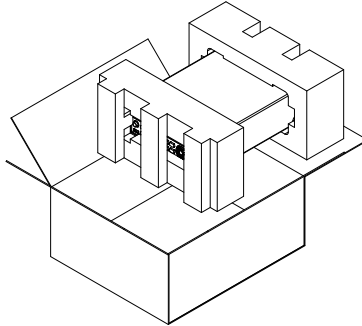

Contents (single unit)

- Main unit
- Test leads (red x2, black x2)
- Power cord x1 (region dependent)
- User manual CD
- Safety instruction sheet

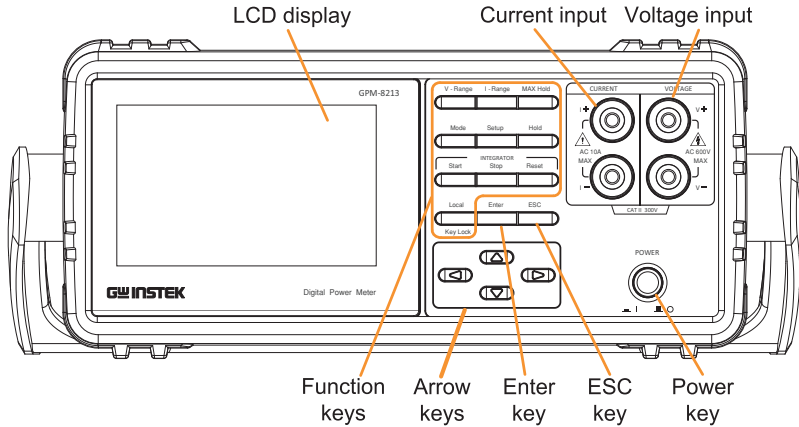

Appearance

Front Panel



Power Switch

POWER

Turns On  or Off  the main power. For the power up sequence, see page 27.

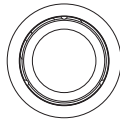

Current, Voltage Terminals

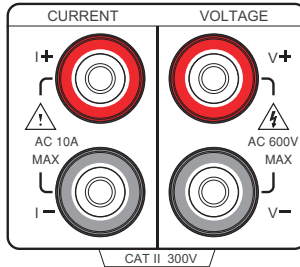

Current input: I+ and I- terminals; Voltage input: V+ and V- terminals.



Note

If the measurement power supply has positive and negative electrode, please connect + to the positive electrode of power supply and - to the negative electrode of power supply.



Warning

The maximum measurable current and voltage are 600 V and 10A for voltage and current terminals of the front panel of the GPM-8213. Do not input exceeded voltage and current, otherwise it will burn the device.

Function keys

V - Range

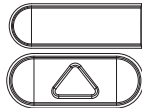

V-Range key, up/down arrow keys and Enter key can be used together to select a voltage range or auto range measurement mode. See page 30.

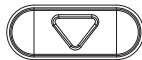

Enter



I - Range

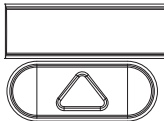

I-Range key, up/down arrow keys and Enter key can be used together to select a current range or auto range measurement mode. See page 30.

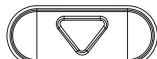

Enter



MAX Hold Press this button to display the maximum measurement reading. See page 51.



Mode Press this key to select measure mode (DC/AC/AC+DC). See page 52.



Setup Press this key to enter the measurement settings menu. See page 34.



Hold Press this key to switch window and stop refreshing. See page 52.



Enter Use the left and right arrow keys to select Integrator mode, and press Enter button to enter the time integrator function. See page 53.



Local Key Lock Press this key to toggle to key lock. In Remote control mode, press this button to switch to local mode. See page 52.



Confirm button

Enter This button is used to enter the menu, confirm the settings and switch between the standard display mode and simple display mode (no function table and display icon). See page 52.



Cancel (Exit)
button



Press this button to cancel the current setting. The cursor returns to the default position or return to the previous menu according to the situation. See page 52.

Arrow Keys

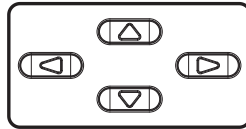

This for arrow keys are used to edit the parameters, browse the menu system and select the parameter range.

Display Overview

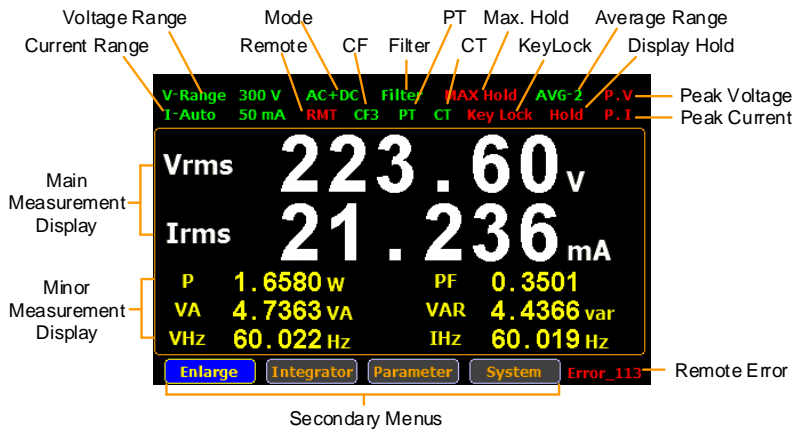

Item	Status icon	Description
Voltage Range	V_Range 300V	Voltage measurement range. Example here range is 300V. V_Auto means that Auto Range is turned on.
Current Range	I_Auto 50mA	Current measurement range. Example here range is 50mA. I_Auto means that Auto Range is turned on.
Mode	AC+DC	Measurement mode (AC, DC, AC+DC)
Remote	RMT	Remote control mode (on/off)
Crest Factor	CF3	Crest Factor (3/6)
Filter	Filter	Voltage and current filters (on/off)
PT Ratio State	PT	External voltage magnification (on/off)

CT Ratio State	CT	External current magnification (on/off)
Maximum Hold	Max. Hold	Retain and display the maximum measurement reading.
Keyboard Lock	KeyLock	Lock Key button
Average	Avg-1	Average number of sampling (1/2/4/8/16/32/64)
Display Hold	Hold	Retain and display the current measurement reading.
Peak Voltage	P.V	The voltage exceeds the measurement range
Peak Current	P.I	The current exceeds the measurement range
Remote Error	Err-XXX	An error occurs in remote command

Standard Display Mode	Display the measurement result of 2 major and 6 minor measurement parameters	
-----------------------	------------------------------------------------------------------------------	--

Simple Display Mode	Display the measurement result of 4 major measurement parameters	
---------------------	------------------------------------------------------------------	--

Secondary menus	Display secondary function menu	
-----------------	---------------------------------	--

- Enlarge This function key is used to switch display of measurement result from 2 major plus 6 minor to 4 major ones.
- Integrator This function key is used to set up integrator measurement parameters and execute integrator measurement function.
- Parameter This function key is used set up measurement parameters.

- System This function key is used to enter the system setting and system configuration screens.

Rear Panel

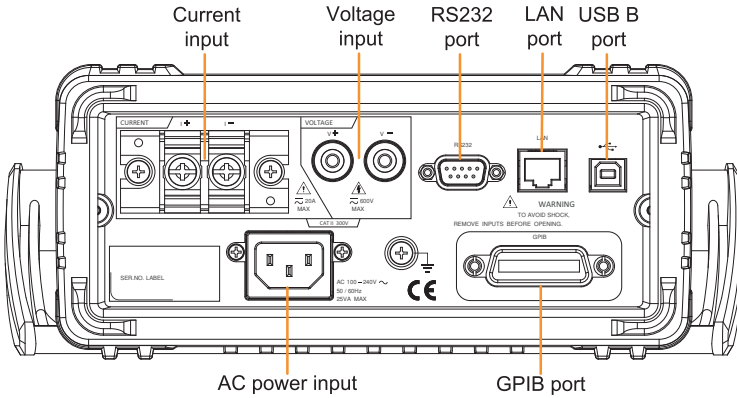

Power Cord Socket

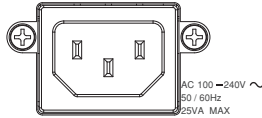

Accepts the power cord.
AC 100~240V $\pm 10\%$,
50/60Hz

RS232

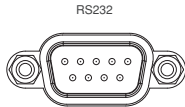

RS232 port. This port is used for remote control.



GPIB port (Option).

USB Device Port

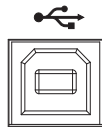

Type B USB port. This port is used for remote control.

LAN Port

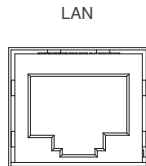

LAN Port.

Rear
Voltage/Current
input terminal

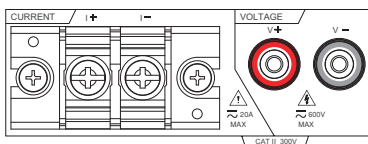

Rear
Voltage/Current
input terminals is
used to connect
the main
measurement
signals.



Warning

- Do not use damaged device. Before using the equipment, check its housing first to sure there is no any cracks. Do not operate this device in an environment containing explosive gases, steam or dust.
- The maximum measurable current and voltage are 600 V and 20A for voltage and current terminals of the rear panel of the GPM-8213. Do not input exceeded voltage and current, otherwise it will burn the device.
- Always use the supplied cable for connection.
- Before connecting the device, observe all the safety symbols marked on the device.
- Turn off the power to the device and the application system before connecting I/O terminals.
- Do not install replacement parts on the device or perform any unauthorized modifications.
- Do not use this device if the removable cover is removed or loosened.
- Do not connect any cables and terminals before performing self-test.
- Use only the power adapter supplied by the manufacturer to avoid accidental injury.
- Do not use this device for life support systems or any other equipment that has safety requirements.

Set Up

Tilting the Stand

From the base of the handle, gently pull the handle out sideways and then rotate it to one of the following positions.

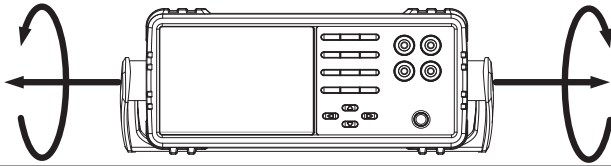

Horizontal position

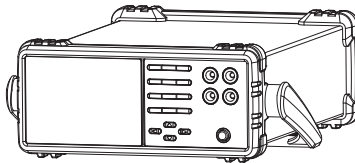

Tilt stand position

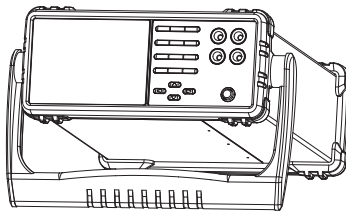

Carry position

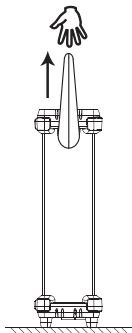

Power Up

Steps

1. Ensure the AC voltage is 100~ 240V.
2. Connect the power cord to the AC voltage input.

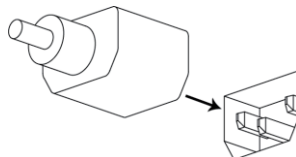

Note

Make sure the ground connector on the power cord is connected to a safety ground. This will influence the measurement accuracy.

3. Push to turn on the main power switch on the front panel.



4. The display turns on and shows the last function that was used before the power was reset.

Connect the wires to the GPM-8213

Background Two separate wires is used to connect the GPM-8213, so voltage and current measurement are isolated and don't interfere with each other.

Connection diagram

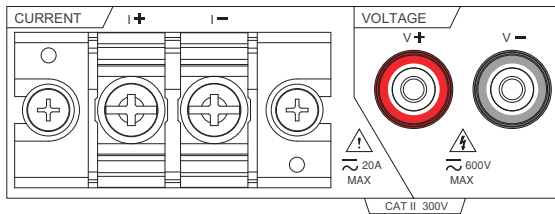
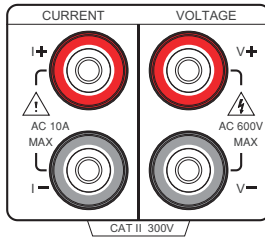

Note

The terminals on the front and rear panels can't be used as input terminal at the same time.

Description

- V + The positive voltage input (+)
- V - The negative voltage input (-)
- I + The positive current input (+), 10A for input on the front panel, 20A for input on the rear panel.
- I - The negative current input (-), 10A for input on the front panel, 20A for input on the rear panel.
- GND Provide reference grounding.

BASIC SETTING

Setting up measurement range	30
Auto Range.....	32
Setting up measurement status	34
Setting up synchronization source	34
Setting up filter.....	35
Setting up crest factor.....	36
Setting up auto-zero function.....	37
Setting up average value.....	38
Setting up method of calculating harmonics	39
Setting up the PT ratio status	40
Setting up the CT ratio status	41
Setting up System status	42
System configuration setting screen	42
Setting up power on status.....	42
Setting up brightness.....	43
Setting up key sound.....	44
Setting up interface.....	45

Setting up measurement range

To get the accurate measurement results, you should set an appropriate measurement range before you perform measurement task.

Set voltage range 1. Press **V-Range** button.

V - Range



2. Use up and down arrow keys to select the desired range.

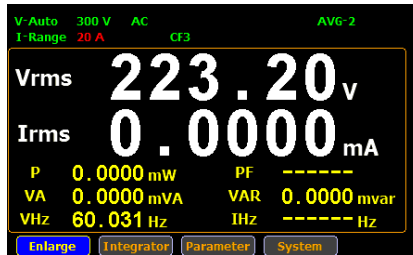

3. Press **Enter** button to confirm your selection.

Enter



Available range Crest Factor AUTO, 15V, 30V, 60V, 150V, 300V, 600V is 3:

Crest Factor AUTO, 7.5V, 15V, 30V, 75V, 150V, 300V is 6:

Set current range 1. Press **I-Range** button.

I - Range



- Use up and down arrow keys to select the desired range.

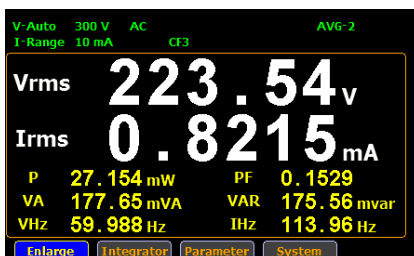
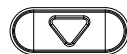
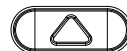

- Press **Enter** button to confirm your selection.

Enter



Available range	Crest Factor AUTO, 5mA, 10mA, 20mA, 50mA, is 3: 100mA, 200mA, 0.5A, 1A, 2A, 5A, 10A, 20A
	Crest Factor AUTO, 2.5mA, 5mA, 10mA, 25mA, is 6: 50mA, 100mA, 250mA, 0.5A, 1A, 2.5A, 5A, 10A



Note

When the measurement range is set manually, if the range status icon lights in green means that the measured value meets the setting range. On the contrary, If the range status icon lights in red means that the measured value doesn't meet the best setting range. In this case. It is better to switch to other range to get more accurate measurement results.



Note

The P.I status icon lights in red when the current measurement circuit detects that the measured value exceeds setting range by 3 folds (CF is set to 3) or 6 folds (CF is set to 6).



Note

The P.V status icon lights in red when the voltage measurement circuit detects that the measured value exceeds setting range by 3 folds (CF is set to 3) or 6 folds (CF is set to 6).

Auto Range

The range is automatically switched according to the voltage and current of input signal.

Range is shift up

The range is shifted up when either of the following conditions is met.

- Vrms or Irms exceeds the current setting range by 110%.
 - The Vpk or Ipk value of the input signal exceeds the current setting range by 330% at CF 3.
 - The Vpk or Ipk value of the input signal exceeds the current setting range by 660% at CF 6.
-

Range is shift down

The range is shifted down when all of the following conditions are met.

- Vrms or Irms is equal to or less than the 60% of previous range.
- The Vpk or Ipk value of the input signal is less than the next setting range by 300% at CF 3.
- The Vpk or Ipk value of the input signal is less than the next setting range by 600% at CF 6.

Example

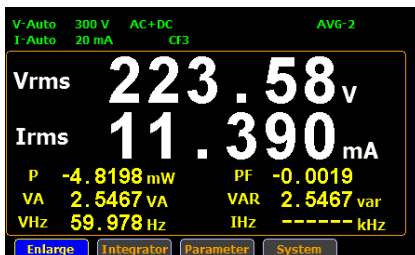



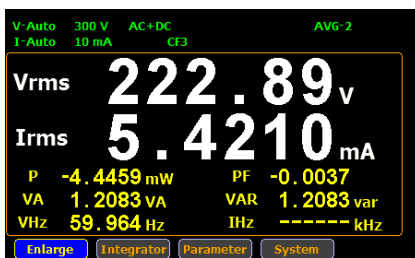



Irms exceeds the current setting range by 110%, so range is shifted to 20mA



Irms is less than or equal to 60% of the previous setting range, so range is shifted down to 10mA.

Setting up measurement status

Setting up synchronization source



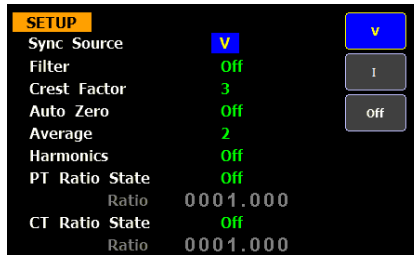



- | | | |
|-------|--------------------------------------------------------------------------------------------------------------------------------------------------------------------------------------------|-----------------------------------------------------------------------------------------------------------------------------------------------------------------------------------------------------------------------------------------------------------------------------------------------------------------------------------------------------------------|
| Steps | 1. Press Setup button. | Setup
 |
| | 2. Press Enter button. | Enter
 |
| | 3. Press down arrow key. |  |
| | 4. Press Enter button to enter Sync Source item. Use up and down arrow keys to select the desired option and then press Enter button again to confirm your selection. | Enter

 
Enter
 |



- | | |
|--------|------------------------------------------------------------------------------------|
| Option | V: Select the voltage of signals as synchronization source. |
| | I: Select the current of signals as synchronization source. |
| | OFF: Select the entire interval of data updating period as synchronization source. |

Default value	V
---------------	---







Setting up filter

- | | | |
|-------|---------------------------------------------------------------------------------------------------------------------------------------------------------------------------------------|-----------------------------------------------------------------------------------------------------------------------------------------------------------------------------------------------------------------------------------------------------------------------------------------------------------------------------------------------------------------|
| Steps | 1. Press Setup button. | Setup
 |
| | 2. Press Enter button. | Enter
 |
| | 3. Press down arrow key twice. |  x2 |
| | 4. Press Enter button to enter Filter item. Use up and down arrow keys to select the desired option and then press Enter button again to confirm your selection. | Enter

 
Enter
 |



- | | |
|---------------|-------------------------------------------------------------------------------------------------------|
| Option | On: Turn on the line filter function and Filter status icon on the display lights up in green. |
| | Off: Turn off the line filter function. Line filter cutoff frequency is 500Hz |
| Default value | Off |

Setting up crest factor

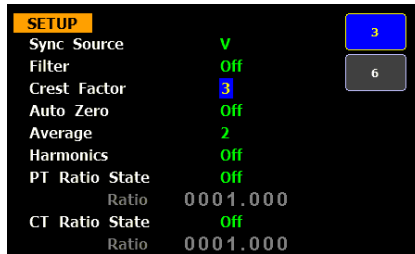





- | | | |
|-------|---------------------------------------------------------------------------------------------------------------------------------------------------------------------------------------------|-----------------------------------------------------------------------------------------------------------------------------------------------------------------------------------------------------------------------------------------------------------------------------------------------------------------------------------------------------------------|
| Steps | 1. Press Setup button. | Setup
 |
| | 2. Press Enter button. | Enter
 |
| | 3. Press down arrow key three times. |  x3 |
| | 4. Press Enter button to enter Crest Factor item. Use up and down arrow keys to select the desired option and then press Enter button again to confirm your selection. | Enter

 
Enter
 |



- | | |
|--------|---------------------------|
| Option | 3: Crest Factor is three. |
| | 6: Crest Factor is six. |

Default value 3

Setting up auto-zero function



- | | | |
|-------|------------------------------------------------------------------------------------------------------------------------------------------------------------------------------------------|-----------------------------------------------------------------------------------------------------------------------------------------------------------------------------------------------------------------------------------------------------------------------------------------------------------------------------------------------------------------|
| Steps | 1. Press Setup button. | Setup
 |
| | 2. Press Enter button. | Enter
 |
| | 3. Press down arrow key four times. |  x4 |
| | 4. Press Enter button to enter Auto Zero item. Use up and down arrow keys to select the desired option and then press Enter button again to confirm your selection. | Enter

 
Enter
 |



- | | |
|--------|----------------------------------------------------------------------------------------------------------------------------------------------------------|
| Option | On: Auto-zero function is activated once per hour or when range is switched |
| | Off: Auto-zero function is only activated once when the range is switched. The auto-zero function is turned off when the integrator function is executed |

Default value Off

Setting up average value

- | | | |
|-------|----------------------------------------------------------------------------------------------------------------------------------------------------------------------------------------|-----------------------------------------------------------------------------------------------------------------------------------------------------------------------------------------------------------------------------------------------------------------------------------------------------------------------------------------------------------------------------------------------------------------------------------------------------------------------------------------------------------------|
| Steps | 1. Press Setup button. | <div style="text-align: right; margin-bottom: 5px;">Setup</div> <input style="width: 100px; height: 20px; border: 1px solid black;" type="text"/> |
| | 2. Press Enter button. | <div style="text-align: right; margin-bottom: 5px;">Enter</div> <input style="width: 100px; height: 20px; border: 1px solid black;" type="text"/> |
| | 3. Press down arrow key five times. |  x5 |
| | 4. Press Enter button to enter Average item. Use up and down arrow keys to select the desired option and then press Enter button again to confirm your selection. | <div style="text-align: right; margin-bottom: 5px;">Enter</div> <input style="width: 100px; height: 20px; border: 1px solid black;" type="text"/> <div style="text-align: right; margin-bottom: 5px;">   </div> <div style="text-align: right;">Enter</div> <input style="width: 100px; height: 20px; border: 1px solid black;" type="text"/> |









Option 1, 2, 4, 6, 8, 16, 32 and 64:

The measurement time is synchronized with the average value that you set. The larger the average value is, the longer the measurement time is. When the average value is set to 1, the measurement time is about 0.1 seconds. The larger the number is, the longer the measurement time is, and so forth.

Default value 2







Setting up method of calculating harmonics

- | | | |
|-------|------------------------------------------------------------------------------------------------------------------------------------------------------------------------------------------|-----------------------------------------------------------------------------------------------------------------------------------------------------------------------------------------------------------------------------------------------------------------------------------------------------------------------------------------------------------------|
| Steps | 1. Press Setup button. | Setup
 |
| | 2. Press Enter button. | Enter
 |
| | 3. Press down arrow key six times. |  x6 |
| | 4. Press Enter button to enter Harmonics item. Use up and down arrow keys to select the desired option and then press Enter button again to confirm your selection. | Enter

 
Enter
 |



- | | |
|---------------|--------------------------------------------------------------------------------------------------------------------------|
| Option | IEC: Calculate the ratio of harmonic quantity of the 2nd through the 13th harmonic to the 1st harmonic. |
| | CSA: Calculate the ratio of harmonic quantity of the 2nd through the 13th harmonic to the 1st through the 13th harmonic. |
| | Off: Turn off the harmonic calculation function. |
| Default value | Off |









Setting up the PT ratio status

- | | | |
|-------|------------------------------------------------------------------------------------------------------------------------------------------------------------------------------------------------|-----------------------------------------------------------------------------------------------------------------------------------------------------------------------------------------------------------------------------------------------------------------------------------------------------------------------------------------------------------------|
| Steps | 1. Press Setup button. | Setup
 |
| | 2. Press Enter button. | Enter
 |
| | 3. Press down arrow key seven times. |  x7 |
| | 4. Press Enter button to enter PT Ratio Status item. Use up and down arrow keys to select the desired option and then press Enter button again to confirm your selection. | Enter

 
Enter
 |



- | | |
|----------------|--------------------------------------------------------------------------------------------------------------------------------------------------|
| Option | On: Turn on the PT ratio calculation function and PT status icon on the display lights up in green. The setting range is from "1" to "9999.999". |
| | Off: Turn off the PT ratio calculation function. |
| Default option | Off |

Setting up the CT ratio status







- | | | |
|-------|------------------------------------------------------------------------------------------------------------------------------------------------------------------------------------------------|-----------------------------------------------------------------------------------------------------------------------------------------------------------------------------------------------------------------------------------------------------------------------------------------------------------------------------------------------------------------|
| Steps | 1. Press Setup button. |  |
| | |  |
| | 2. Press Enter button. | Enter
 |
| | 3. Press down arrow key eight times. |  x8 |
| | 4. Press Enter button to enter CT Ratio Status item. Use up and down arrow keys to select the desired option and then press Enter button again to confirm your selection. | Enter

 
Enter
 |

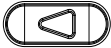

- | | |
|----------------|--------------------------------------------------------------------------------------------------------------------------------------------------|
| Option | On: Turn on the CT ratio calculation function and CT status icon on the display lights up in green. The setting range is from "1" to "9999.999". |
| | Off: Turn off the CT ratio calculation function. |
| Default option | Off |

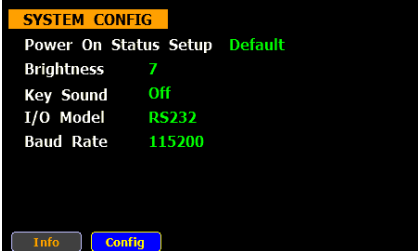
Setting up System status

System configuration setting screen

- | | | |
|-------|---------------------------------------------------------------------------------------------------------------------------------------------|------------------------------------------------------------------------------------------------------------------------------------------------------------------------|
| Steps | <ol style="list-style-type: none"> 1. Use left and right arrow keys on the front panel to select System function key. | 
 |
| | <ol style="list-style-type: none"> 2. Press Enter button to Enter SYSTEM INFORMATION setting screen. | Enter
 |
| | <ol style="list-style-type: none"> 3. Press right arrow key to select Config key. |  |
| |  | |
| | <ol style="list-style-type: none"> 4. Press Enter button to enter SYSTEM CONFIG setting screen. | Enter
 |

Setting up power on status

Background Continue the following setting from **SYSTEM CONFIG** setting screen

- | | | |
|-------|----------------------------------------------------------------------------|-------------------------------------------------------------------------------------|
| Steps | <ol style="list-style-type: none"> 1. Press down arrow key. |  |
|-------|----------------------------------------------------------------------------|-------------------------------------------------------------------------------------|

2. Press **Enter** button to enter **Power On Status Setup** item. Use up and down keys to select the desired option and then press **Enter** button again to confirm your selection.

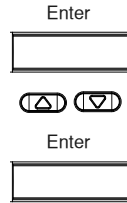

Option	Previous: The status of device on powering on is set to the status before the last shutdown.
	Default: The status of device on powering on is set to the factory default status.
Default value	Default

Setting up brightness

Background Continue the following setting from **SYSTEM CONFIG** setting screen

- | | | |
|-------|--------------------------------|----------------------------------------------------------------------------------------|
| Steps | 1. Press down arrow key twice. |  x2 |
|-------|--------------------------------|----------------------------------------------------------------------------------------|

- Press **Enter** button to enter **Brightness** item. Use up and down keys to select a number and then press **Enter** button again to confirm your selection.

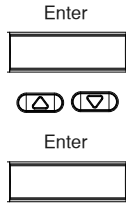

Option	1 to 9	The display is the darkest when set to 1. On the contrary, the brightest when set to 9.
--------	--------	-----------------------------------------------------------------------------------------

Default option	7
----------------	---

Setting up key sound

Background	Continue the following setting from SYSTEM CONFIG setting screen
------------	-------------------------------------------------------------------------

- | | |
|-------|-----------------------------------------|
| Steps | 1. Press down arrow key three times. x3 |
|-------|-----------------------------------------|

2. Press **Enter** button to enter **Key Sound** item. Use up and down arrow keys to select the desired option and then press **Enter** button again to confirm your selection.

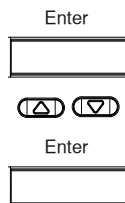

Option	On:	A short sound is heard from the speaker of device when pressing the keys on the front panel.
	Off:	No sound from the speaker of device when pressing the keys on the front panel.

Default option Off

Setting up interface

Background Continue the following setting from **SYSTEM CONFIG** setting screen

- Steps 1. Press down arrow key four times.  x4

- Press **Enter** button to enter **I/O Model** item. Use up and down arrow keys to select the desired option and then press **Enter** button again to confirm your selection.

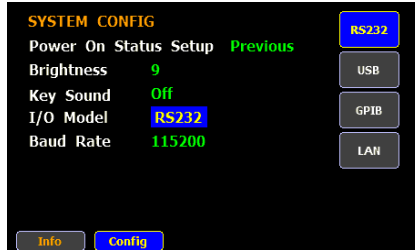
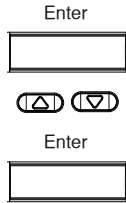

Option	<p>RS232: If interface is set to RS232, the Baud Rate can be selected from the following options. 1200, 2400, 4800, 9600, 19200, 38400, 57600 or 115200 For details about configuring RS 232 interface, please see page 61.</p> <p>USB: For details about configuring USB interface, please see page 61.</p> <p>GPIB: If interface is set to GPIB, the GPIB address can be selected from “1” to “30”</p> <p>LAN: If interface is set to LAN, the IP model is can be selected from “Manual” and “DHCP”. For details about configuring USB interface, please see page 62.</p>
Default value	RS232, 9600

M EASUREMENT AND O THER FUNCTIONS

Measurement function	48
Introduction to measurement parameters.....	48
Setting measurement parameters.....	49
Other functions	51
Introduction to other functions.....	51
Integration measurement function	53
Setting up Integrator measurement.....	53
Introduction to integrator parameters	56
Using the integrator function	58

Measurement function

The GPM-8213 provides a wide range of basic electricity and power measurement functions. It equips with different accurate measurement parameters for accurately measuring the voltage, current, power, DC/AC/AC + DC, power factor, harmonics, frequency, etc. The input impedance of the device is 2.4MΩ, the maximum input voltage is 600Vrms. There are 2 sets of internal resistance (Shunt), 500mΩ and 5mΩ respectively. The maximum input current is 20Arms. The device will issue a warning sound when the input voltage and current exceed 700 Vrms or 25Arms.

Introduction to measurement parameters

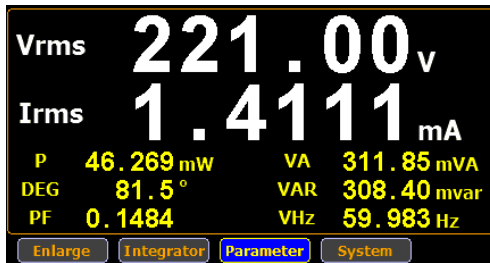

Parameter name Display icon

Voltage Vdc (DC voltage), Vrms (AC voltage)

Current Idc (DC current), Irms (AC current)

Active Power P

Apparent Power VA

Reactive power VAR

Power Factor PF

Phase Angle DEG

Frequency IHz and VHz

Voltage Peak V+pk and V-pk

Current Peak I+pk and I-pk

Active Power Peak P+pk and P-pk

Total Harmonic Distortion THDI and THDV

Crest factor CFV, CFI

Setting measurement parameters

Please follow the steps blow to set the measurement parameters

Steps

1. Use left and right arrow keys on the front panel to select **Parameter** function key.



2. Press **Enter** button. A measurement parameter will be highlighted in green.

Enter



3. Press **Enter** button to confirm setting or use up and down arrow keys to select other desired measurement parameter.

Enter



Enter

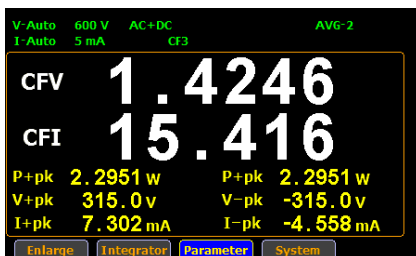

4. You can use same way as show in last step to set other measurement parameters in this screen.

- Switching display mode 5. In standard display mode, you simply press the **Enter** button to switch display mode to simple one.

Enter

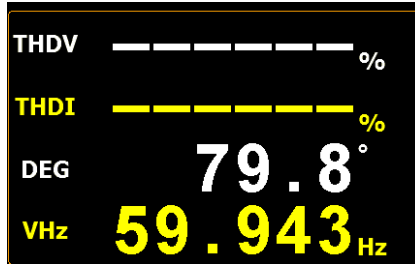

6. Press **ESC** button to return back to original display mode.

ESC

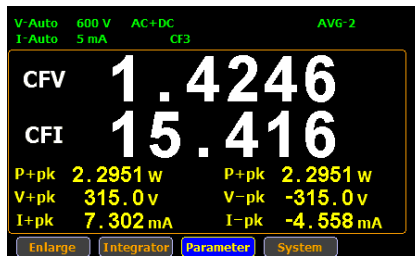



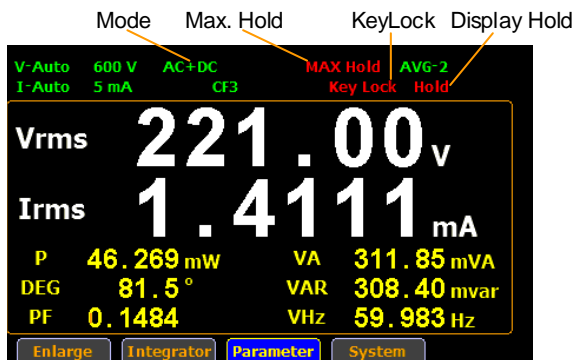

Other functions

Introduction to other functions



Function name	Button	Description
MAX Hold	<p>MAX Hold</p> 	<p>When the MAX Hold button is pressed, the MAX Hold status icon will light in red in the LCD display to indicate that this function is activated. To deactivate this function, press this button again.</p> <p>If the MAX Hold function is activated, the display value on the display is updated only when the current measured value is greater than the previous measured value. The maximum display value is retained on the display.</p>

Mode	<div style="text-align: center;">Mode</div> 	<p>Press this button to select measurement mode. There are 3 measurement modes.</p> <ul style="list-style-type: none"> • AC+DC: Displays all the components of the measurement signal • DC: Displays the DC part of the measurement signal. • AC: Displays the AC part of the measurement signal.
<hr/>		
Hold	<div style="text-align: center;">Hold</div> 	<p>When the Hold button is pressed, the Hold status icon will light in red in the LCD display to indicate that this function is activated. To deactivate this function, press this button again.</p> <p>When the Hold function is activated, the displayed value on the LCD display is not updated and the range is locked. Measurement is performed in the background.</p>
<hr/>		
Local/ KeyLock	<div style="text-align: center;">Local</div>  <div style="text-align: center;">Key Lock</div>	<p>Dual function key. When Remote mode is activated, press this button to deactivate Remote mode and switch to Local mode. When Remote mode is not activated, this button is used as lock key of keypad.</p>
<hr/>		
Enter	<div style="text-align: center;">Enter</div> 	<p>This button is used to select function or confirm selection.</p>
<hr/>		
ESC	<div style="text-align: center;">ESC</div> 	<p>This button is used to exit current screen or return to main measurement screen.</p>

Integration measurement function

Setting up Integrator measurement

steps

1. Use left and right arrow keys on the front panel to select **Integrator** function key.

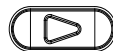
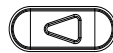

2. Press **Enter** button to enter the integrator measurement screen.

Enter



3. Press right arrow key to select **Set** key.

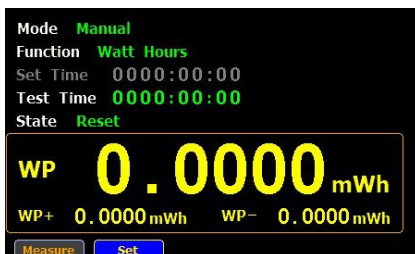

Select integrator measurement mode

4. Press **Enter** button to enter integrator measurement setting screen.

Enter

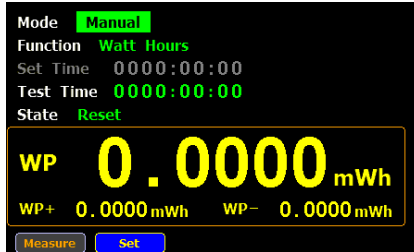

5. Press **Enter** button to enter **Mode** item. Use up and down arrow keys to toggle between Manual and Standard mode. Press Enter button again to confirm your selection.

Enter



Enter

If you select Manual mode, the Set time become disable and displayed in gray.

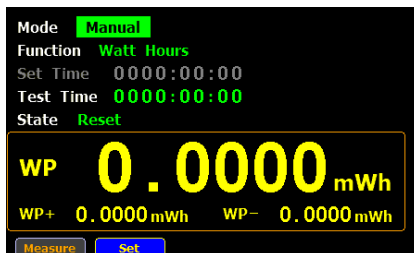

If you select standard mode, you need to set integrator measurement time before using integrator function. It can be set from 1 second to 9999 hours, 59 minutes and 59 seconds.

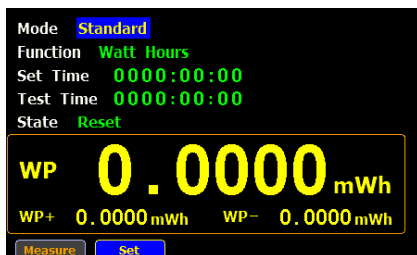

6. Press down arrow key to select **Function** item in the integrator measurement setting screen.



Select integrator measurement function

7. Press **Enter** button to enter **Function** item. Use up and down arrow keys to toggle between Ampere Hours and Watt Hours. Press Enter button again to confirm your selection.

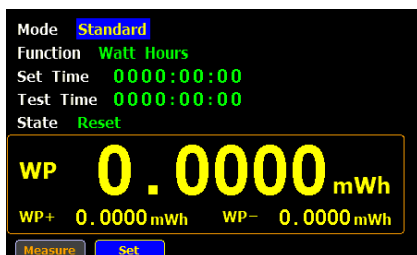
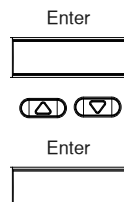

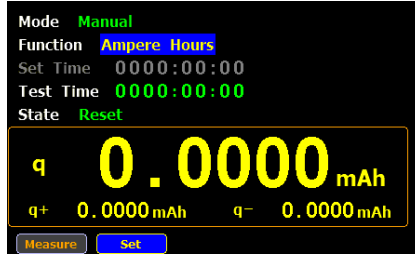

Introduction to integrator parameters

Parameter name	Description
----------------	-------------

Mode	<ul style="list-style-type: none"> • Manual • Standard
------	----------------------------------------------------------------------------------------------

Function	<ul style="list-style-type: none"> • Watt Hours WP: Total power WP+: Positive total power WP-: Negative total power • Ampere Hours q: Total mAh q+: Positive total mAh q-: Negative total mAh
----------	-------------------------------------------------------------------------------------------------------------------------------------------------------------------------------------------------------------------------------------------------------------------------------------------------------------------------------------------------------------------------------------------

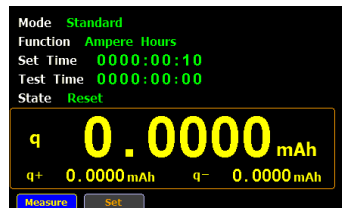
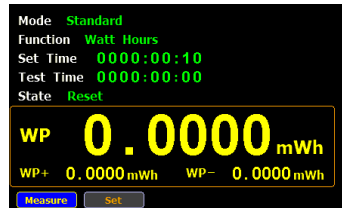

Set time	It indicates the time of integrator measurement to be set. It can be set from 1 second to 9999 hours, 59 minutes and 59 seconds.
----------	----------------------------------------------------------------------------------------------------------------------------------

Test time	It indicates that elapsed time of integrator measurement.
-----------	-----------------------------------------------------------

State

- **Running**
Integrator measurement is in progress.
- **Stop**
Integrator measurement has been stopped manually.
- **Timeout**
The time for running integrator measurement is up.
- **Reset**
The integrator measurement status is cleared.

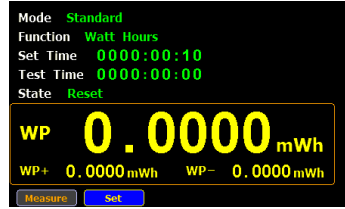
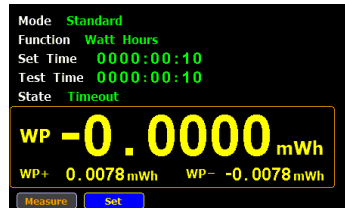

Using the integrator function

Manual mode

1. In manual mode, you can directly press the **Start** button in the front panel to start integrator function.

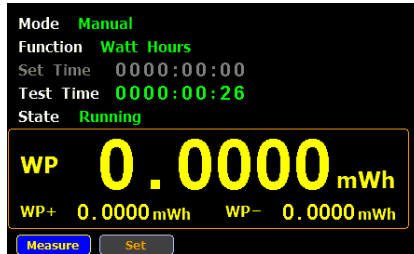
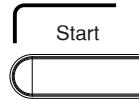

2. To stop integration function, press the **Stop** button in the front panel.

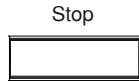

3. Press the **Reset** button in the front panel to clear integrator.

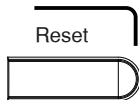

- Standard mode
1. Set integrator measurement time before using integrator function.
 2. Other steps are same as running in manual mode.

When integrator performing, the test time will increase until the setting integrator measurement time.

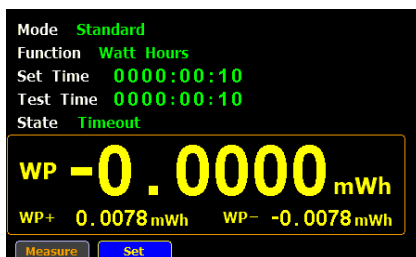

- In the integration process, select the **Measure** key and press **Enter** button to return main measurement screen. Select **Integrator** key and press **Enter** button to switch back to integration measurement screen.
- In the integration process, you can't change measurement range and enter system to set measurement parameters.
- In the integration process, if the voltage or current measurement value exceeds, the measured value will display in red.

REMOTE CONTROL

This chapter describes basic configuration of IEEE488.2 based remote control. For a command list, refer to the Command Overview chapter on page 65.

Configure Remote Control Interface	61
USB Interface	61
Configure USB Interface	61
Configure RS232 Interface	61
Configure LAN Interface	62
Return to Local Control	64

Configure Remote Control Interface

USB Interface

The USB device port on the rear panel is used for remote control. The USB port is configured as CDC interface.

When configured to CDC, the USB port on the GPM-8213 will appear as a virtual COM port to a connected PC. Any terminal program that can communicate via a serial port can be used for remote control. Before the GPM-8213 can be used for remote control using the CDC USB class, install the appropriate CDC USB driver included on the User Manual CD.

Configure USB Interface

USB Configuration	PC connector	Type A, host
	GPM-8213 connector	Rear panel Type B, slave
	Speed	1.1/2.0 (full speed/high speed)
	USB Class	CDC (Communications device class)
	Hardware flow control	Off
	Data Bits	8
	Stop bit	1

Configure RS232 Interface

RS232 Configuration	Selectable Baud rate	1200, 2400, 4800, 9600, 19200, 38400, 57600, 115200
	Parity	None
	Hardware flow control	Off
	Data Bits	8
	Stop bit	1

RS232 Pin Assignments

Pin 2: RxD
 Pin 3: TxD
 Pin 5: GND
 Pin 1, 4, 6 ~ 9: No Connection

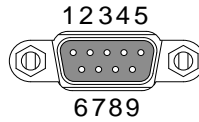

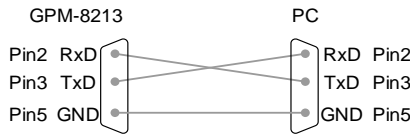

PC Connection Use a Null Modem connection as shown in the diagram below.

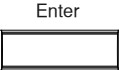

Configure LAN Interface

Background Continue the following setting from **SYSTEM CONFIG** setting screen

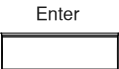
- Steps
1. Press down arrow key four times.  x4
 2. Press **Enter** button to enter **I/O Model** item. Use up and down arrow keys to select **LAN** option and then press **Enter** button again to confirm your selection.

 

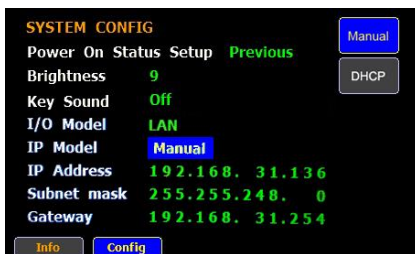

3. Select a desired IP Model.



Option	Manual	Set up IP Address, Subnet mask and Gateway manually.
	DHCP	For details about configuring USB interface, please see page 61.

Return to Local Control

Background When the unit is in remote control mode, the RMT icon above the main display can be seen. When this icon is not displayed, it indicates that the unit is in local control mode.

- Procedure**
1. Press the LOCAL key when in remote mode.
 2. The unit will go back into local mode and the RMT icon will turn off.

C COMMAND OVERVIEW

The Command overview chapter lists all programming commands in functional order as well as alphabetical order. The command syntax section shows you the basic syntax rules you have to apply when using commands.

Command Syntax

Compatible
Standard

IEEE488.2

Partial compatibility

SCPI, 1994

Partial compatibility

Command
Structure

SCPI (Standard Commands for Programmable Instruments) commands follow a tree-like structure, organized into nodes. Each level of the command tree is a node. Each keyword in a SCPI command represents each node in the command tree. Each keyword (node) of a SCPI command is separated by a colon (:). For example, the diagram below shows an SCPI sub-structure and a command example.

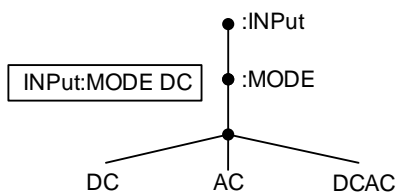

Command Types There are a number of different instrument commands and queries. A command sends instructions or data to the unit and a query receives data or status information from the unit.

Command types

Simple A single command with/without a parameter

Example :INPut:MODE DC

Query A query is a simple or compound command followed by a question mark (?). A parameter (data) is returned.

Example :INPut:CFACTOR?

Command Forms Commands and queries have two different forms, long and short. The command syntax is written with the short form of the command in capitals and the remainder (long form) in lower case.

The commands can be written either in capitals or lower-case, just so long as the short or long forms are complete. An incomplete command will not be recognized.

Below are examples of correctly written commands.

Long form :INPut:SYNChronize VOLTage
:COMMunicate:HEADer ON

Short form :INP:SYNC VOLT
:COMM:HEAD ON

Square Brackets Commands that contain square brackets indicate that the contents are optional. The function of the command is the same with or without the square bracketed items, as shown below. For example, for the query:

[:INPut]:FILTer?

Both :INPut:FILTer? and :FILTer? are valid forms.

Command
Format

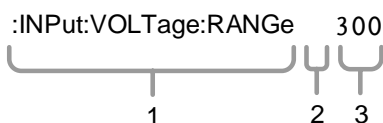

1. Command header
2. Space
3. Parameter 1

Common Input Parameters	Type	Description	Example
	<Boolean>	boolean logic	0, 1
	<NR1>	integers	0, 1, 2, 3
	<NR2>	decimal numbers	0.1, 3.14, 8.5
	<NR3>	floating point with exponent	4.5e-1, 8.25e+1
	<NRf>	any of NR1, 2, 3	1, 1.5, 4.5e-1
	[MIN] (Optional parameter)	For commands, this will set the setting to the lowest value. This parameter can be used in place of any numerical parameter where indicated. For queries, it will return the lowest possible value allowed for the particular setting.	

<p>[MAX] (Optional parameter)</p>	<p>For commands, this will set the setting to the highest value. This parameter can be used in place of any numerical parameter where indicated.</p> <p>For queries, it will return the highest possible value allowed for the particular setting.</p>
-------------------------------------------	--------------------------------------------------------------------------------------------------------------------------------------------------------------------------------------------------------------------------------------------------------

<p>Message Terminator (EOL)</p>	<p>Remote Command</p>	<p>Marks the end of a command line. The following messages are in accordance with IEEE488.2 standard.</p>
	<p>CR+LF</p>	<p>The most common EOL character is CR+LF</p>

<p>Message Separator</p>	<p>EOL or ; (semicolon)</p>	<p>Command Separator</p>
--------------------------	---------------------------------	--------------------------

Command List

SCPI Commands	*CLS	71
	*IDN	71
	*ESE	71
	*ESR	72
	*OPC	72
	*RST	72
	*SRE	73
	*STB	73
COMMunicate Commands	:COMMunicate:HEADer	74
	:COMMunicate:REMote	74
	:COMMunicate:VERBoSe	75
DISPlay Commands	:DISPlay[:NORMal]:ITEM<x>	76
	:DISPlay:INTEgrate:ITEM<x>	77
	:DISPlay:PAGE	78
HARMonics Command	:HARMonics:THD	79
HOLD Command	:HOLD	80
INPut Commands	[:INPut]:CFACtor	81
	[:INPut]:MODE	81
	[:INPut]:VOLTage:RANGe	82
	[:INPut]:VOLTage:AUTO	82
	[:INPut]:CURRent:RANGe	83
	[:INPut]:CURRent:AUTO	83
	[:INPut]:SCALing: {VT/PT CT}:STATe	84
	[:INPut]:SCALing: {VT/PT CT}:RATio	84
	[:INPut]:SYNChronize	84
	[:INPut]:FILTer	85
	[:INPut]:ZERO	85

INTEgrate	:INTEgrate:MODE	87
commands	:INTEgrate:FUNCTion.....	87
	:INTEgrate:TImEr.....	88
	:INTEgrate:STARt.....	88
	:INTEgrate:STOP	88
	:INTEgrate:RESet.....	88
	:INTEgrate:STATe	89
MEASure	:MEASure:AVErAgIng:COUnT.....	90
commands	:MEASure:MHOLd	90
NUMeric	:NUMeric[:NORMal]:VALue?.....	91
commands	:NUMeric[:NORMal]:NUMBer.....	92
	:NUMeric[:NORMal]:ITEm<x>	92
	:NUMeric[:NORMal]:PRESet.....	94
	:NUMeric[:NORMal]:CLEAr	96
	:NUMeric[:NORMal]:DELete	97
	:INTEgrate:STATe	97
SYSTem	:SYSTem:MODEl?.....	98
commands	:SYSTem:MODEl?.....	98
	:SYSTem:VERSion?.....	98
	:SYSTem:KLOCK	99
	:SYSTem:BRIGhtness	99
	:SYSTem:KEY:BEEPer.....	100
STATus command	:STATus:ERRor?	101

SCPI Commands

*CLS	71
*IDN	71
*ESE	71
*ESR	72
*OPC	72
*RST	72
*SRE	73
*STB	73

*CLS

Set →

Description Clears the Event Status register (Output Queue, Operation Event Status, Standard Event Status).

Syntax *CLS

*IDN

→ Query

Description Returns the manufacturer, model number, serial number, and system version of the instrument.

Query Syntax *IDN?

Return parameter <String>

Example *IDN?
->GWINSTEK,GPM-8213, GXXXXXXXXX,V1.00

Set →

*ESE

→ Query

Description Sets or returns the ESER (Event Status Enable Register) contents.

Syntax *ESE <NR1>

Query Syntax *ESE?

Parameter/	<NR1>	0~255
Return parameter		
Example	*ESE 65 Set the ESER to 01000001 *ESE? ->130 ESER=10000010	

***ESR** → Query

Description	Returns SESR (Standard Event Status Register).	
Query Syntax	*ESR?	
Return parameter	<NR1>	0~255
Example	*ESR? ->198 SESR=11000110	

Set →

***OPC** → Query

Description	Sets or returns the operation complete bit (bit0) in SERS (Standard Event Status Register) when all pending operations are completed.	
Syntax	*OPC	
Query Syntax	*OPC?	
Return parameter	<NR1>0	Operation isn't completed
	<NR1>1	Operation is completed
Example	*OPC? Returns 1.	

Set →

***RST** Set →

Description	Initializes the settings
Syntax	*RST





***SRE**

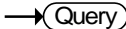

Description	Sets or returns SRE (Service Request Enable Register)	
Syntax	*SRE <NR1>	
Query Syntax	*SRE?	
Parameter/ Return parameter	<NR1>	0~255
Example	*SER 7 Set the the SRER to 00000111 *SRE? ->3 SRER=0000011	



Description	Returns the SBR (Status Byte Register) contents.	
Query Syntax	*STB?	
Return parameter	<NR1>	0~255
Example	*STB 8 ->81 SESR=01010001	

COMMunicate Commands

:COMMunicate:HEADer	74
:COMMunicate:REMote.....	74
:COMMunicate:VERBose	75

	
:COMMunicate:HEADer	
Description	Sets or returns whether headers are attached to query responses
Syntax	:COMMunicate:HEADer <Boolean> {OFF ON}
Query Syntax	:COMMunicate:HEADer?
Parameter	<Boolean>0 OFF <Boolean>1 ON
Return parameter	0 Turn the header function off 1 Turn the header function on
Example	:COMMUNICATE:HEADER ON :COMMUNICATE:HEADER? ->:COMMUNICATE:HEADER 1
Note	Example of a response with a header :INPUT:VOLTAGE:RANGE 150.0E+00 Example of a response without a header 150.0E+00

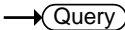
	
:COMMunicate:REMote	
Description	Sets or returns the GPM-8213 series to remote or local mode. ON is remote mode.
Syntax	:COMMunicate:REMote <Boolean> {OFF ON}
Query Syntax	:COMMunicate:REMote?

Parameter	<Boolean>0	OFF
	<Boolean>1	ON
Return parameter	0	Turn the remote function off
	1	Turn the remote function on
Example	:COMMUNICATE:REMOTE ON :COMMUNICATE:REMOTE? ->:COMMUNICATE:REMOTE 1	

:COMMunicate:VERBose

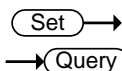

Description	Sets or returns whether the response to a query is returned fully spelled out or in its abbreviated form.	
Syntax	:COMMunicate:VERBose <Boolean> {OFF ON}	
Query Syntax	:COMMunicate:VERBose?	
Parameter	<Boolean>0	OFF
	<Boolean>1	ON
Return parameter	0	Turn the verbose function off
	1	Turn the verbose function on
Example	:COMMUNICATE:VERBOSE ON :COMMUNICATE:VERBOSE? ->:COMMUNICATE:VERBOSE 1	
Note	Example of a response fully spelled out :INPUT:VOLTAGE:RANGE 150.0E+00 Example of a response in abbreviated form :VOLT:RANG 150.0E+00	

DISPlay Commands

:DISPlay[:NORMal]:ITEM<x>	76
:DISPlay:INTEgrate:ITEM<x>	77
:DISPlay:PAGE.....	78

:DISPlay[:NORMal]:ITEM<x>
Set →
 ← Query

Description	Sets or returns a normal measurement data display item.	
Syntax	:DISPlay[:NORMal]:ITEM<x> <Function>	
Query Syntax	:DISPlay[:NORMal]:ITEM<x>?	
Parameter/ Return parameter	<x> <Function>	1 to 8 (display) {U UPPeak UMPeak IPPeak IMPeak P PPPeak PMPeak S Q LAMBda CFU CFI PHI FU FI UTHD ITHD}
Example	:DISPLAY:NORMAL:ITEM1 U :DISPLAY:NORMAL:ITEM1? ->:DISPLAY:NORMAL:ITEM1 U	

<Function>	Function	GPM-8213 Indicator
U	Voltage U	[V]
UPPeak	Maximum voltage: U+pk	[V+pk]
UMPeak	Minimum voltage: U-pk	[V-pk]
I	Current I	[I]
IPPeak	Maximum current: I+pk	[I+pk]
IMPeak	Minimum current: I-pk	[I-pk]
P	Active power P	[P]
PPPeak	Maximum power: P+pk	[P+pk]
PMPeak	Minimum power: P-pk	[P-pk]
S	Apparent power S	[VA]

Q	Reactive power Q	[VAR]
LAMBda	Power factor λ	[PF]
CFU	Voltage factor λ	[CFV]
CFV	Current factor λ	[CFI]
PHI	Phase difference Φ	[DEG]
FU	Voltage frequency fu	[VHz]
FI	Current frequency fl	[AHZ]
UTHD	Total harmonic distortion of voltage Uthd	[THDV]
ITHD	Total harmonic distortion of current Ithd	[THDI]

Set →
 → Query

:DISPlay:INTEgrate:ITEM<x>

Description	Sets or returns a Integrate measurement data display item.	
Syntax	:DISPlay:INTEgrate:ITEM<x> <Function>	
Query Syntax	:DISPlay:INTEgrate:ITEM<x>?	
Parameter/	<x>	1 to 2 (display)
Return parameter	<Function>	{WHP WHM AHP AHM U I }.
Example	:DISPLAY:INTEGRATE:ITEM1 WHP :DISPLAY:INTEGRATE:ITEM1? ->:DISPLAY:INTEGRATE:ITEM1 WHP	

<Function>	Function	GPM-8213 Indicator
WHP	Positive watt hour WP+	[WP+]
WHM	Positive watt hour WP-	[WP-]
AHP	Positive ampere hour q+	[q+]
AHM	Positive ampere hour q	[q-]
U	Voltage U	[V]
I	Current I	[I]

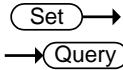

:DISPlay:PAGE

Description	Sets or returns the display page item.	
Syntax	:DISPlay:PAGE <Function>	
Query Syntax	:DISPlay:PAGE?	
Parameter/ Return parameter	<Function>	{MEASurement ENLArge INTEgral SYSTem_INfO SYSTem_CONfIg SETUp}
Example	:DISPlay:PAGE MEASUREMENT :DISPlay:PAGE? ->:DISPlay:PAGE MEASUREMENT	

HARMonics Command

:HARMonics:THD



Description	Sets or returns the equation used to compute the THD (total harmonic distortion).	
Syntax	:HARMonics:THD {TOTal FUNDamental}	
Query Syntax	:HARMonics:THD?	
Parameter/ Return parameter	TOTAL	(CSA)
	FUNDamental	(IEC)
Example	:HARMONICS:THD FUNDAMENTAL :HARMONICS:THD? ->:HARMONICS:THD FUNDAMENTAL	

HOLD Command

:HOLD

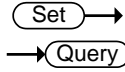

Description Sets or returns the on/off state of the output hold feature for display, communication, and other types of data.

Syntax :HOLD <Boolean>|{OFF|ON}

Query Syntax :HOLD?

Parameter	<Boolean>0	OFF
	<Boolean>1	ON

Return parameter	0	Turn the hold function off
	1	Turn the hold function on

Example

```
:HOLD OFF
:HOLD?
->:HOLD 0
```

INPut Commands

[:INPut]:CFACtor	81
[:INPut]:MODE	81
[:INPut]:VOLTag:e:RANGe	82
[:INPut]:VOLTag:e:AUTO	82
[:INPut]:CURRent:RANGe	83
[:INPut]:CURRent:AUTO	83
[:INPut]:SCALIng: {VT/PT CT}:STATe	84
[:INPut]:SCALIng: {VT/PT CT}:RATio	84
[:INPut]:SYNChronize	84
[:INPut]:FILTer	85
[:INPut]:ZERO	85

[:INPut]:CFACtor Set → → Query

Description	Sets or returns the crest factor.	
Syntax	[:INPut]:CFACtor {<NRf>}	
Query Syntax	[:INPut]:CFACtor?	
Parameter/ Return parameter	<NR1>	3, 6
Example	:INPUT:CFACtor 3 :INPUT:CFACtor? ->:INPUT:CFACtor 3	

[:INPut]:MODE Set → → Query

Description	Sets or returns the voltage and current measurement mode.	
Syntax	[:INPut]:MODE {DC ACDC AC}	
Query Syntax	[:INPut]:MODE?	

Parameter/ Return parameter Select the dc measurement mode.
 Select the acdc measurement mode.
 Select the ac mode.

Example :INPUT:MODE DC
 :INPUT:MODE?
 ->:INPUT:MODE DC

Set →
 → Query

[:INPut]:VOLTage:RANGe

Description	Sets or returns the voltage range.	
Syntax	[:INPut]:VOLTage:RANGe {<Voltage>}	
Query Syntax	[:INPut]:VOLTage:RANGe?	
Parameter/ Return parameter	<Voltage>	15, 30, 60, 150, 300, 600(V) when the crest factor is set to 3. 7.5, 15, 30, 75, 150, 300(V) when the crest factor is set to 6
Example	:INPUT:VOLTAGE:RANGE 600V :INPUT:VOLTAGE:RANGE? ->:INPUT:VOLTAGE:RANGE 600.0E+00	

Set →
 → Query

[:INPut]:VOLTage:AUTO

Description	Sets or returns the voltage auto range on/off state.	
Syntax	[:INPut]:VOLTage:AUTO {<Boolean>}	
Query Syntax	[:INPut]:VOLTage:AUTO?	
Parameter	<Boolean>0	OFF
	<Boolean>1	ON
Return parameter	0	Turn the voltage auto range function off.
	1	Turn the voltage auto range function on.

Example :INPUT:VOLTAGE:AUTO ON
 :INPUT:VOLTAGE:AUTO?
 ->:INPUT:VOLTAGE:AUTO 1

[[:INPut]:CURRent:RANGe

Set →

→ Query

Description	Sets or returns the current range.
Query	[[:INPut]:CURRent:RANGe {<Current>}
Query Syntax	[[:INPut]:CURRent:RANGe?
Parameter/ Return parameter	<Current> 5, 10, 20, 50, 100, 200, 500(mA) 1, 2, 5, 10, 20(A) when the crest factor is set to 3. 2.5, 5, 10, 25, 50, 100, 250(mA) 0.5, 1, 2.5, 5, 10(A)when the crest factor is set to 6

Example :INPUT:CURRENT:RANGE 20A
 :INPUT:CURRENT:RANGE?
 ->:INPUT:CURRENT:RANGE 20.0E+00

[[:INPut]:CURRent:AUTO

Set →

→ Query

Description	Sets or returns the current auto range on/off state.
Syntax	[[:INPut]:CURRent:AUTO {<Boolean>}
Query Syntax	[[:INPut]:CURRent:AUTO?
Parameter	<Boolean>0 OFF <Boolean>1 ON
Return parameter	0 Turn the current auto range function off. 1 Turn the current auto range function on.

Example :INPUT:CURRENT:AUTO ON
 :INPUT:CURRENT:AUTO?
 ->:INPUT:CURRENT:AUTO 1

Set →
 → Query

[:INPut]:SCALing:{VT/PT CT}:STATe	
Description	Sets or returns the scaling vt/pt,ct on/off state.
Syntax	[:INPut]:SCALing:{VT/PT CT}:STATe {<Boolean>}
Query Syntax	[:INPut]:SCALing:{VT/PT CT}:STATe?
Parameter	<div style="display: flex; justify-content: space-between;"> <Boolean>0 OFF</div> <div style="display: flex; justify-content: space-between;"> <Boolean>1 ON</div>
Return parameter	<div style="display: flex; justify-content: space-between;"> 0 Turn the scaling vt/pt, ct function off.</div> <div style="display: flex; justify-content: space-between;"> 1 Turn the scaling vt/pt, ct function on.</div>
Example	:INPUT:SCALING:VT:STATE ON :INPUT:SCALING:VT:STATE? ->:INPUT:SCALING:VT:STATE 1

Set →
 → Query

[:INPut]:SCALing:{VT/PT CT}:RATio	
Description	Collectively Sets or returns the vt/pt ratio or ct ratio.
Syntax	[:INPut]:SCALing:{VT/PT CT}:RATio {<NRf>}
Query Syntax	[:INPut]:SCALing:{VT/PT CT}: RATio?
Parameter/ Return parameter	<div style="display: flex; justify-content: space-between;"> <NRf> 1.000 to 9999.999</div>
Example	:INPUT:SCALING:VT:RATIO 1 :INPUT:SCALING:VT:RATIO? ->:INPUT:SCALING:VT:RATIO 1

Set →
 → Query

[:INPut]:SYNChronize	
Description	Sets or returns the synchronization source.
Syntax	[:INPut]:SYNChronize {VOLTage CURRent OFF}
Query Syntax	[:INPut]:SYNChronize?

Parameter/	Select the voltage synchronization source.
Return parameter	Select the current synchronization source.
	Select the off synchronization source.

Example	:INPUT:SYNCHRONIZE VOLTAGE
	:INPUT:SYNCHRONIZE?
	->:INPUT:SYNCHRONIZE VOLTAGE





[:INPut]:FILTer

Description	Sets or returns the filter state.	
Syntax	[:INPut]:FILTer {<Boolean>}	
Query Syntax	[:INPut]:FILTer?	
Parameter	<Boolean>0	OFF
	<Boolean>1	ON
Return parameter	0	Turn the filter function off.
	1	Turn the filter function on.
Example	:INPUT:FILTER OFF	
	:INPUT:FILTER?	
	->:INPUT:FILTER 0	





[:INPut]:ZERO

Description	Sets or returns the zero state.	
Syntax	[:INPut]:ZERO {<Boolean>}	
Query Syntax	[:INPut]:ZERO?	
Parameter	<Boolean>0	OFF
	<Boolean>1	ON
Return parameter	0	Turn the zero function off.
	1	Turn the zero function on.

Example :INPUT:ZERO OFF
 :INPUT:ZERO?
 ->:INPUT:ZERO 0

INTEgrate Commands

:INTEgrate:MODE	87
:INTEgrate:FUNcTion.....	87
:INTEgrate:TIMer	88
:INTEgrate:STARt.....	88
:INTEgrate:STOP	88
:INTEgrate:RESet.....	88
:INTEgrate:STATe	89

:INTEgrate:MODE



Description	Sets or returns the integration mode.	
Syntax	:INTEgrate:MODE {MANUAl STANdard}	
Query Syntax	:INTEgrate:MODE?	
Parameter/ Return parameter	MANUAl	Continuous integration mode.
	STANdard	Standard integration mode.
Example	:INTEGRATE:MODE MANUAL :INTEGRATE:MODE? ->:INTEGRATE:MODE MANUAL	

:INTEgrate:FUNcTion



Description	Sets or returns the integration function.	
Syntax	:INTEgrate:FUNcTion {WATT AMPERe}	
Query Syntax	:INTEgrate: FUNcTion?	
Parameter/ Return parameter	WATT	Select the integration function watt.
	AMPERe	Select the integration function ampere.
Example	:INTEGRATE:FUNCTION WATT :INTEGRATE:FUNCTION? ->:INTEGRATE:FUNCTION WATT	

Set →

→ Query

:INTEgrate:TIMer

Description	Sets or returns the integration timer value.	
Syntax	:INTEGrate:TIMer {<NRf>,<NRf>,<NRf>}	
Query Syntax	:INTEGrate:TIMer?	
Parameter/ Return parameter	{<NRf>,<NRf>,<NRf>}	0,0,0 to 9999,59,59 0 to 9999 (hours) 0 to 59 (minutes) 0 to 59 (seconds)
Example	:INTEGRATE:TIMER 1,0,0 :INTEGRATE:TIMER? ->:INTEGRATE:TIMER 1,0,0	

:INTEgrate:STARt

Set →

Description	Starts integration.
Syntax	:INTEgrate:STARt
Example	:INTEGRATE:START

:INTEgrate:STOP

Set →

Description	Stops integration.
Syntax	:INTEgrate:STOP
Example	:INTEGRATE:STOP

:INTEgrate:RESet

Set →

Description	Resets the integrated value.
Syntax	:INTEgrate:RESet
Example	:INTEGRATE:RESET

:INTegrate:STATe

→ Query

Description	Queries the integration status.	
Syntax	:INTegrate:STATe?	
Example	:INTEGRATE:STATE? ->RESET	
Response	Overflow	Integration overflows.
	RESET	Integration resets.
	RUNNING	Integration is in progress.
	STOP	Integration stops.
	TIMEUP	Integration stops due to integration timeout.

MEASure Commands

:MEASure:AVERaging:COUNT.....	90
:MEASure:MHOLd	90

:MEASure:AVERaging:COUNT



Description	Sets or returns the averaging coefficient.	
Syntax	:MEASure:AVERaging:COUNT {<NRF>}	
Query Syntax	:MEASure:AVERaging:COUNT?	
Parameter/ Return parameter	<NRF>	1, 2, 4, 8, 16, 32, 64
Example	:MEASURE:AVERAGING:COUNT 8 :MEASURE:AVERAGING:COUNT? ->:MEASURE:AVERAGING:COUNT 8	

:MEASure:MHOLD



Description	Sets the MAX hold on/off state.	
Syntax	:MEASure:MHOLD {<Boolean>}	
Query Syntax	MEASure:MHOLD?	
Parameter	<Boolean>0	OFF
	<Boolean>1	ON
Return parameter	0	Turn the MAX hold function off.
	1	Turn the MAX hold function on.
Example	:MEASURE:MHOLD ON :MEASURE:MHOLD? ->:MEASURE:MHOLD 1	

NUMeric Commands

:NUMeric[:NORMal]:VALue?	91
:NUMeric[:NORMal]:NUMBer	92
:NUMeric[:NORMal]:ITEM<x>	92
:NUMeric[:NORMal]:PRESet	94
:NUMeric[:NORMal]:CLEar	96
:NUMeric[:NORMal]:DELete	97
:INTegrate:STATe	97

:NUMeric[:NORMal]:VALue?

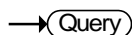

Description	Returns the numeric data.
Syntax	:NUMeric[:NORMal]:VALue?
Example	:NUMERIC:NORMAL:VALUE? -> 103.79E+00,1.0143E+00,105.27E+00,..(omitted)...,50.001E+00
Numeric Data Format	<ul style="list-style-type: none"> • Measurement values U, I, P, PPPeak, PMPeak, S, Q, LAMBda, CFU, CFI, FU, FI, UTHD and ITHD • Integrated values WH, WHP, WHM, AH, AHP and AHM. ASCII: <NR3> format. Example: [-]12.345E+00 • Measurement values UPPeak, UMPeak, IPPeak and IMPeak. ASCII: <NR3> format. Example: [-]12.34E+00 • Measurement values (PHI) ASCII: <NR3> = 0~9.9 format. Example: [-]9.9E+00 ASCII: <NR3> = 10~99.9 format. Example: [-]99.9E+00 ASCII: <NR3> = 100~999.9 format. Example: [-]999.9E+000 • Elapsed integration time (TIME) ASCII: <NR1> format in units of seconds. Example: 3600 for 1 hour (1:00:00).

- No items (“-----”)
ASCII: NAN (Not A Number)

Error Data • Data does not exist (the display shows “-----”)
ASCII: NAN (Not A Number)

:NUMeric[:NORMal]:NUMBER Set →
← Query

Description Sets or returns the specified numeric data output item function.

Syntax :NUMeric[:NORMal]:ITEM<x> {<Function>}ALL}

Query Syntax :NUMeric[:NORMal]:NUMBER?

Parameter/ Return parameter	<NRf>	1 to 34(ALL)
--------------------------------	-------	--------------

Example :NUMERIC:NORMAL:NUMBER 10
 :NUMERIC:NORMAL:NUMBER
 ->:NUMERIC:NORMAL:NUMBER 10

Note • If the parameter is omitted from the :NUMeric[:NORMal]:VALue? command, the numeric data items from 1 to the specified value are output in order.

- By default, the number of numeric data items is set to 3.

:NUMeric[:NORMal]:ITEM<x> Set →
← Query

Description Sets or returns the specified numeric data output item function.

Syntax :NUMeric[:NORMal]:ITEM<x> {<Function>}

Query Syntax :NUMeric[:NORMal]:ITEM<x>?

Parameter/ Return parameter	<x> <Function>	1 to 34 (item number) {U UPPeak UMPeak I IPPeak IMPeak P PPPeak PMPeak S Q LAMBda CFU CFI PHI FU FI UTHD ITHD WH WHP WHM AH AHP AHM TIME URANge IRANge}
--------------------------------	-------------------	----------------------------------------------------------------------------------------------------------------------------------------------------------------------------

Example :NUMERIC:NORMAL:ITEM1 U
:NUMERIC:NORMAL:ITEM1?
->:NUMERIC:NORMAL:ITEM1 U

<Function>	Function	GPM-8213 Indicator
U	Voltage U	[V]
UPPeak	Maximum voltage: U+pk	[V+pk]
UMPeak	Minimum voltage: U-pk	[V-pk]
I	Current I	[I]
IPPeak	Maximum current: I+pk	[I+pk]
IMPeak	Minimum current: I-pk	[I-pk]
P	Active power P	[P]
PPPeak	Maximum power: P+pk	[P+pk]
PMPeak	Minimum power: P-pk	[P-pk]
S	Apparent power S	[VA]
Q	Reactive power Q	[VAR]
LAMBda	Power factor λ	[PF]
CFU	Voltage factor λ	[CFV]
CFV	Current factor λ	[CFI]
PHI	Phase difference Φ	[DEG]
FU	Voltage frequency fu	[VHz]
FI	Current frequency fl	[AHz]
UTHD	Total harmonic distortion of voltage Uthd	[THDV]

ITHD	Total harmonic distortion of current Ithd	[THDI]
WH	Watt hour WP	[WP]
WHP	Positive watt hour WP+	[WP+]
WHM	Positive watt hour WP-	[WP-]
AH	Ampere hour q	[q]
AHP	Positive ampere hour q+	[q+]
AHM	Positive ampere hour q-	[q-]
TIME	Integration time	
URANge	Voltage range	
IRANge	Current range	

:NUMeric[:NORMal]:PRESet



Description Presets the numeric data output item pattern.

Syntax :NUMeric[:NORMal]:PRESet {<Nrf>}

Parameter/ Return parameter	<Nrf>	1 to 4
----------------------------------------	-------	--------

Example :NUMERIC:NORMAL:PRESET 1

Patterns 1	ITEM<x>	<Function>
	1	U
	2	I
	3	P

Patterns 2	ITEM<x>	<Function>
	1	U
	2	I
	3	P
	4	S
	5	Q
6	LAMBda	

	7	PHI
	8	FU
	9	FI
Patterns 3	ITEM<x>	<Function>
	1	U
	2	I
	3	P
	4	S
	5	Q
	6	LAMBda
	7	PHI
	8	FU
	9	FI
	10	UPPeak
	11	UMPeak
	12	IPPeak
	13	IMPeak
	14	PPPeak
	15	PMPeak
Patterns 4	ITEM<x>	<Function>
	1	U
	2	I
	3	P
	4	S
	5	Q
	6	LAMBda
	7	PHI
	8	FU
	9	FI

10	UPPeak
11	UMPeak
12	IPPeak
13	IMPeak
14	TIME
15	WH
16	WHP
17	WHM
18	AH
19	AHP
20	AHM
21	PPPeaK
22	PMPeaK
23	CFU
24	CFI
25	UTHD
26	ITHD
27	URANge
28	IRANge

:NUMeric[:NORMal]:CLEar



Description Clears numeric data output items (sets the items to "-----").

Syntax :NUMeric[:NORMal]:CLEar {ALL|<NRf>[,<NRf>]}

Parameter	First <NRf>	1 to 34 (the number of the first item to clear)
	Second <NRf>	1 to 34 (the number of the last item to clear)

Example :NUMERIC:NORMAL:CLEAR ALL

Note If the 2nd <Nrf> is omitted, the output item specified by the first and all following output items (up to number 34) are cleared.

:NUMeric[:NORMal]:DElete (Set) →

Description Deletes numeric data output items.

Syntax :INTEgrate:RESet

Parameter	First <Nrf>	1 to 34 (the number of the first item to delete)
	Second <Nrf>	1 to 34 (the number of the last item to delete)

Example :NUMERIC:NORMAL:DELETE 1 (Deletes ITEM1 and shifts ITEM2 and subsequent items forward).
 :NUMERIC:NORMAL:DELETE 1,3 (Deletes ITEM1 to ITEM3 and shifts ITEM4 and subsequent items forward).:INTEGRATE:RESET

- Note
- When output items are deleted, subsequent items shift forward to fill the empty positions. Empty positions at the end are set to “-----”.
 - If the second <Nrf> is omitted, only the output item specified by the first number is deleted.

:INTEgrate:STATe → (Query)

Description Returns the numeric data header.

Syntax :NUMeric[:NORMal]:HEADer?

Example :NUMERIC:NORMAL:HEADER?
 ->U,I,P

SYSTem Commands

:SYSTem:MODEl?	98
:SYSTem:MODEl?	98
:SYSTem:VERSion?	98
:SYSTem:KLOCK	99
:SYSTem:BRIGhtness	99
:SYSTem:KEY:BEEPPer	100

:SYSTem:MODEl? → Query

Description	Returns the model code.
Syntax	:SYSTem:MODEl?
Example	:SYSTEM:MODEL? ->:SYSTEM:MODEL "GPM-8213"

:SYSTem:MODEl? → Query

Description	Returns the serial number.
Syntax	:SYSTem:SERial?
Example	:SYSTEM:SERIAL? ->:SYSTEM:SERIAL "123456789A"
Note	Returns the No. item string of the system Information menu.

:SYSTem:VERSion? → Query

Description	Returns the firmware version.
Syntax	:SYSTem:VERSion?
Example	:SYSTEM:VERSION? ->"V1.00"

Note Returns the Ver. item string of the system Information menu.

:SYSTem:KLOCK

Set →

→ Query

Description Sets or returns the on/off state of the key protection.

Syntax :SYSTem:KLOCK {<Boolean>}

Query Syntax :SYSTem:KLOCK?

Parameter	<Boolean> 0	OFF
	<Boolean> 1	ON

Return parameter	0	Turn the key protection function off
	1	Turn the key protection function on.

Example :SYSTEM:KLOCK OFF
:SYSTEM:KLOCK?
->:SYSTEM:KLOCK 0

:SYSTem:BRIGhtness

Set →

→ Query

Description Sets or returns the brightness level.

Syntax :SYSTem:BRIGhtness {<NRf>}

Query Syntax :SYSTem:BRIGhtness?

Parameter/	<NRf>	1 to 9
------------	-------	--------

Return parameter

Example :SYSTEM:BRIGHTNESS 7
:SYSTEM:BRIGHTNESS?
->:SYSTEM:BRIGHTNESS 7

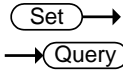

:SYSTem:KEY:BEEPer

Description	Sets or returns the keyclick beeper state.	
Syntax	:SYSTem:KEY:BEEPer {<Boolean>}	
Query Syntax	:SYSTem:COMMunicate:LAN:CONFigure?	
Parameter	<Boolean> 0	OFF
	<Boolean> 1	ON
Return parameter	0	Turn the keyclick beeper function off.
	1	Turn the keyclick beeper function on.
Example	:SYSTEM:KEY:BEEPER OFF :SYSTEM:KEY:BEEPER? ->:SYSTEM:KEY:BEEPER 0	

STATus Command

:STATus:ERRor?

→ Query

Description	Queries the error code and message of the last error that has occurred (top of the error queue).
-------------	--------------------------------------------------------------------------------------------------

Query Syntax	:STATus:ERRor?
--------------	----------------

Example	:STATUS:ERROR? -> Error_103:Invalid separator
---------	--------------------------------------------------

Note	<ul style="list-style-type: none"> If no errors have occurred, 0, "No error" is returned. Error_103: Invalid separator Error_104: Data type error. Error_108: Parameter not allowed. Error_109: Missing parameter. Error_113: Undefined header. Error_131: Invalid suffix. Error_141: Invalid character data. Error_221: Setting conflict. Error_222: Data out of range. Error_813: Invalid operation.
------	-----------------------------------------------------------------------------------------------------------------------------------------------------------------------------------------------------------------------------------------------------------------------------------------------------------------------------------------------------------------------------------------------------------------------------------------------------------------------------------------------------------------

APPENDIX

Specifications	103
General Specifications	103
Input	104
Display	104
Voltage Measurement	105
Current Measurement	105
Power Measurement	106
Frequency Measurement	106
Integrator Measurement	106
Dimensions	107
Declaration of Conformity	108
Power measurement	109
Measurement for small current	109
Measurement for large current	110
Introduction to IEC-62301	111
Recommended parameters for power measurement	111
EUP Directive Lot6 specifications	112
Connection Guide	113
Front panel	113
Lower current measurement: $I < 1A$	113
Higher current measurement: $1A < I < 10A$	113
Rear panel	114
Direct connection: $10A < I < 20A$	114
Connection with CT/PT	114

Specifications

Below are the basic conditions required to operate the GPM-8213 within specification:

- Calibration: Yearly
- Operating Environment: 18~28 °C (64.4~82.4°F)
- Humidity: <80%RH,
- Accuracy: ± (% of reading + % of range)
- The specifications apply when it warmed up for at least 30 minutes and operates in the slow rate.
- The power supply cable must be grounded to ensure accuracy.
- Input voltage and current must be standard sine wave.
- The power factor must be 1.
- The crest factor must be 3.
- The common-mode voltage must be zero.

General Specifications

Specification Conditions:

Temperature: 23 °C±5 °C

Humidity: <80%RH(non-condensing)

Operating Environment: (0~40 °C)

Temperature Range: 30~40 °C, Relative Humidity: <70%RH(non-condensing);

>40 °C, Relative Humidity: <50%RH(non-condensing)

Indoor use only

Altitude: <2000 meters

Pollution degree 2

Storage Conditions (-40~70 °C)

Humidity: <90%RH(non-condensing)

General:

Power Consumption: Max 25VA

Dimensions: 270 mm (W) X 110 mm (H) X 350 mm (D)

Weight: Approximately 2.9 kg

Input

Item	Spec.	
Input voltage	600 Vrms	
Input current	20 Arms	
Input impedance(50/60 Hz)	Voltage	2.4MΩ
	Current	5mA - 200mA
		500mΩ
		0.5A - 20A
		5mΩ
Maximum display voltage	700 Vrms	
Maximum display current	25 Arms	
Maximum allowable isolation voltage	300 V	
Low frequency filter	Cut-off frequency	500 Hz

Display

Synchronization frequency	45Hz~ 6kHz
Average	1, 2, 4, 8, 16, 32, 64
Displayed items(Standard mode)	8 items simultaneously.
Displayed items(Simple mode)	4 items simultaneously.
Displayed digits	5
Voltage converter	1 to 9999.999
Current converter	1 to 9999.999
Measurement items	Voltage, current, active power, apparent power, reactive power, power factor, phase angle, frequency, integrated current, integrated power, positive integrated power, negative integrated power, integration time, voltage crest factor, current crest factor, voltage peak, current peak, Thd
Displayed measurement parameters	Vdc, Vrms, V+pk, V-pk, Idc, Irms, I+pk, I-pk, P, P+pk, P-pk, VA, VAR, PF, CFV, CFI, DEG, VHz, IHz, THDV, THDI

Voltage Measurement

Measurement range	CF=3 : 15V, 30V, 60V, 150V, 300V, 600V CF=6 : 7.5V, 15V, 30V, 75V, 150V, 300V
Crest factor	3, 6
Effective range	1 % to 105 % of range
DC	$\pm(0.2 \% \text{ reading} + 0.2 \% \text{ range})$
45 Hz $\leq f \leq$ 66 Hz	$\pm(0.1 \% \text{ reading} + 0.1 \% \text{ range})$
66 Hz $< f \leq$ 1kHz	$\pm(0.1 \% \text{ reading} + 0.2 \% \text{ range})$
1 kHz $< f \leq$ 6kHz	$\pm 3 \% \text{ of range}$
The filter is turned on	Increase 0.3 % reading@ 45Hz to 66Hz
Temperature effect	5-18 °C / 28-40 °C Increase $\pm 0.03\%$ reading / °C
Residual noise	0.5 % of range

Current Measurement

Measurement range	5mA, 10mA, 20mA, 50mA, CF=3 : 100mA, 200mA, 500mA, 1A, 2A, 5A, 10A, 20A 2.5mA, 5mA, 10mA, 25mA, CF=6 : 50mA, 100mA, 250mA, 0.5A, 1A, 2.5A, 5A, 10A
Crest factor	3, 6
Effective range	1 % to 105 % of range
DC	$\pm(0.2 \% \text{ reading} + 0.2 \% \text{ range})$
45 Hz $\leq f \leq$ 66 Hz	$\pm(0.1 \% \text{ reading} + 0.1 \% \text{ range})$
66 Hz $< f \leq$ 1kHz	$\pm(0.1 \% \text{ reading} + 0.2 \% \text{ range})$
1 kHz $< f \leq$ 6kHz	$\pm 3 \% \text{ of range}$
The filter is turned on	Increase 0.3 % reading@ 45Hz to 66Hz
Temperature effect	5-18 °C / 28-40 °C Increase $\pm 0.03\%$ reading / °C
Residual noise	0.5 % of range

Power Measurement

Accuracy	Effective range	1 % to 110 % of range
	DC	$\pm(0.2 \% \text{ reading} + 0.2 \% \text{ range})$
	$45 \text{ Hz} \leq f \leq 66 \text{ Hz}$	$\pm(0.1 \% \text{ reading} + 0.1 \% \text{ range})$
	$66 \text{ Hz} < f \leq 1\text{kHz}$	$\pm(0.1 \% \text{ reading} + 0.3 \% \text{ range})$
	$1 \text{ kHz} < f \leq 6\text{kHz}$	$\pm 3 \% \text{ of range}$
Temperature effect	The filter is turned on	Increase 0.3 % reading@ 45Hz to 66Hz
	5-18 °C / 28-40 °C	Increase $\pm 0.03\% \text{ reading} / ^\circ\text{C}$

Frequency Measurement

Measurement range	The filter is turned on	30.000Hz to 499.99Hz
	The filter is turned off	30.000Hz to 9.9999kHz
Measurement items	Voltage, Current	
Effective input range	10% to 105% of voltage input range	
Accuracy	$\pm(0.06 \% \text{ reading})$	

Integrator Measurement

Integrator	Accuracy	$\pm(\text{Accuracy of voltage or current} + 0.1 \% \text{ reading})$
Time	Range	0 hour 0 minute to 9999 hours 59 minutes
	Accuracy	$\pm 0.01\% \pm 1\text{second}$

Dimensions

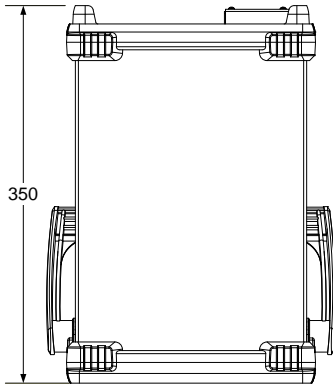

Units = mm

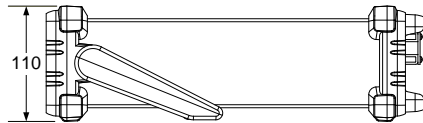
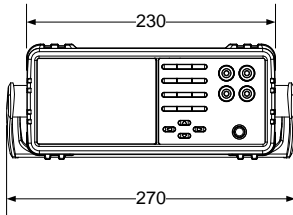

Declaration of Conformity

We

GOOD WILL INSTRUMENT CO., LTD.

declare that the below mentioned product

Type of Product: Digital Power Meter

Model Number: GPM-8213

are herewith confirmed to comply with the requirements set out in the Council Directive on the Approximation of the Law of Member States relating to EMC (2014/30/EU), LVD (2014/35/EU), WEEE (2012/19/EU) and RoHS (2011/65/EU).

For the evaluation regarding the Electromagnetic Compatibility and Low Voltage Directive, the following standards were applied:

© EMC	
EN 61326-1 : EN 61326-2-1:	Electrical equipment for measurement, control and laboratory use — EMC requirements (2013)
Conducted and Radiated Emissions EN 55011:2016	Electrical Fast Transients EN 61000-4-4: 2012
Current Harmonic EN 61000-3-2:2014	Surge Immunity EN 61000-4-5: 2014
Voltage Fluctuation EN 61000-3-3:2013	Conducted Susceptibility EN 61000-4-6: 2014
Electrostatic Discharge EN 61000-4-2: 2009	Power Frequency Magnetic Field EN 61000-4-8:2010
Radiated Immunity EN 61000-4-3:2006+A1:2008+A2:2010	Voltage Dips/ Interrupts EN 61000-4-11: 2004
Low Voltage Equipment Directive 2014/35/EU	
Safety Requirements	EN 61010-1:2010 (Third Edition) EN 61010-2-030:2010 (First Edition)

GOODWILL INSTRUMENT CO., LTD.

No. 7-1, Jhongsing Road, Tucheng District, New Taipei City 236, Taiwan

Tel: [+886-2-2268-0389](tel:+886-2-2268-0389)

Fax: [+886-2-2268-0639](tel:+886-2-2268-0639)

Web: <http://www.gwinstek.com>

Email: marketing@goodwill.com.tw

GOODWILL INSTRUMENT (SUZHOU) CO., LTD.

No. 521, Zhujiang Road, Snd, Suzhou Jiangsu 215011, China

Tel: [+86-512-6661-7177](tel:+86-512-6661-7177)

Fax: [+86-512-6661-7277](tel:+86-512-6661-7277)

Web: <http://www.instek.com.cn>

Email: marketing@instek.com.cn

GOODWILL INSTRUMENT EURO B.V.

De Run 5427A, 5504DG Veldhoven, The Netherlands

Tel: [+31-\(0\)40-2557790](tel:+31-(0)40-2557790)

Fax: [+31-\(0\)40-2541194](tel:+31-(0)40-2541194)

Email: sales@gw-instek.eu

Power measurement

- Method
- Direct read method: Directly read the measurement value measured from power measuring instrument.
 - The average power method: Record the actual power value within a settable period of time and then take the average. A settable period of time isn't less than 10min. The maximum measurement interval is one second.
 - Energy accumulation method: Measure the energy within a settable period of time and then divide it by the time to get the power. A settable period of time isn't less than 10min. The cumulative energy must be greater than the resolution by 200 times.
-

Measurement for small current

Voltage measurement mode measured from power supply side (Connect to ammeter internally). The current measurement is accurate. The voltage measurement on load could be larger than the actual one due to partial pressure of multi-measurement ammeter.

Connection

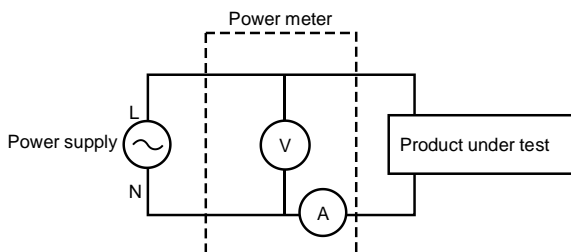

$$\text{Power loss} = (\text{Input current}[\text{A}])^2 \times 500\text{m}\Omega$$

Measurement for large current

Voltage measurement mode measured from load side (Connect to ammeter externally).

The voltage measurement is accurate. The current measurement on load could be larger than the actual one due to leakage current of multi-measurement voltage.

Connection

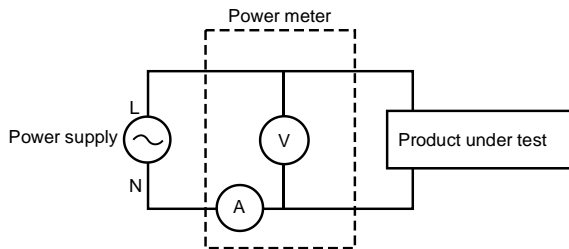

$$\text{Power loss} = (\text{Input voltage}[\text{V}])^2 / 2.4\text{M}\Omega$$

Introduction to IEC-62301

IEC 62301-2011 standard is an international basic standard for measuring standby power consumption of household appliances which is issued by IEEC. It is a standby power consumption measurement method for the various household appliances, power supply, audio and video appliances to comply with. The latest version for this standard is second edition of German standard IEC62301: 2011 (British regulations EN50564: 2011) which is issued on January, 2011. Only the products comply to the standard can have CE marking affixed on it.

Recommended parameters for power measurement

- Power resolution is less than or equal to 1mW.
- Time integrator function is available.
- Electric energy resolution is less than or equal to 1mWh and cumulative time resolution is less than or equal to 1 second.
- The crest factor is greater than or equal to 3.
- The minimum current range is less than or equal to 10mA.
- The active power includes AC and DC components.
- Over-range automatic alarm function is available.
- Turning off the auto range function is available.
- Harmonic bandwidth is greater than or equal to 2.5kHz.

The GPM-8213 meets all of the features listed above.

EUP Directive Lot6 specifications

Ecodesign directive for energy-using products:

The power loss requirement for the products with external power supply such as information devices, consumer electronics product, household appliances, toys, entertainment and sports products and so on in standby and off mode is as below.

Mode/Limit		2010.01	2013.01
Standby mode	Products with time display function.	≤ 2W	≤ 1W
	Products without time display function.	≤ 1W	≤ 0.5W
Shutdown mode		≤ 1W	≤ 0.5W

Connection Guide

Front panel

Lower current measurement: $I < 1A$

Method 1

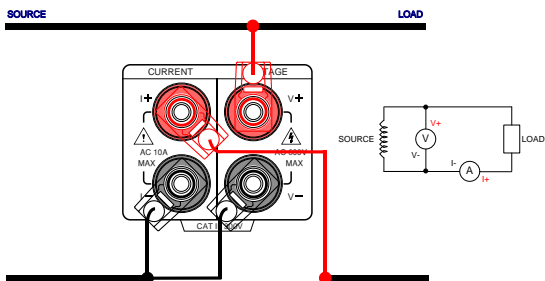

Method 2

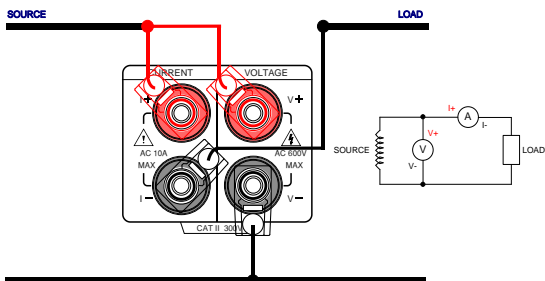

Higher current measurement: $1A < I < 10A$

Method 1

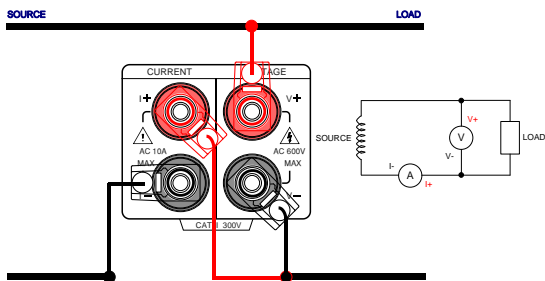

Method 2

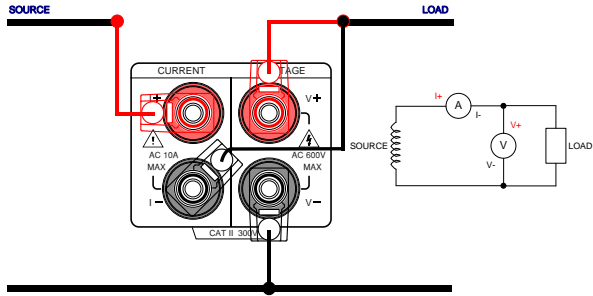

Rear panel

Direct connection: $10A < I < 20A$

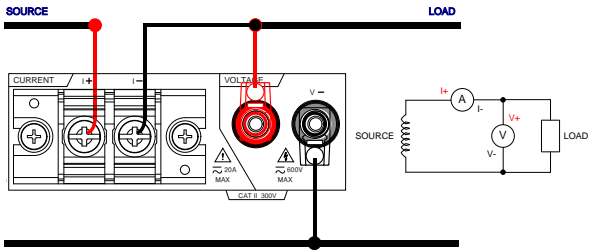

Connection with CT/PT

