

JBC

www.jbctools.com

INSTRUCTION MANUAL



Heavy Duty station

Ref. HDE-D

Packing List

The following items are included:

HDE Control Unit 1 unit
 Ref. HDE-1UD (120V)
 HDE-2UD (230V)
 HDE-9UD (100V)



Stand 1 unit
 Ref. HD-SE

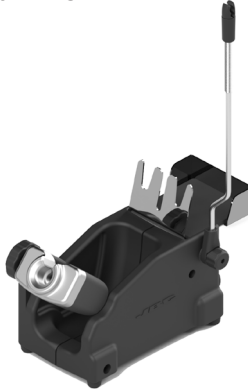

HD Purpose Handle 1 unit
 Ref. T470-FA



ESD Tip Cleaner 1 unit
 Ref. CL8499



Sponge 1 unit
 Ref. S0354



Cartridge holder..... 1 unit
 Ref. SCH-A



Stand cable 1 unit
 Ref. 0011283



Power Cord 1 unit
 Ref. 0010569 (230V)
 0013671 (100/120V)



Manual 1 unit
 Ref. 0020641

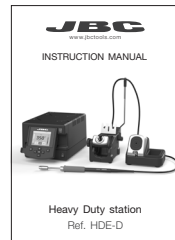

Connections

HDE Control Unit

Stand cable
Ref. 0011283

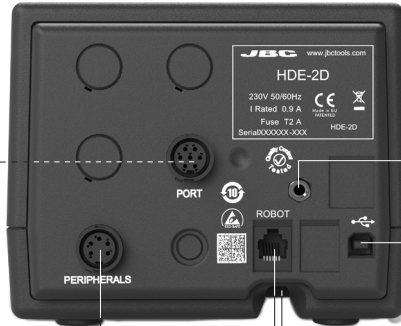

Equipotential connection

USB-B connector

Power Socket

RJ12 connector
for Robot system

Peripheral connector
for joining modules
and pedals

C470 cartridges
Required but not supplied

**HD Purpose
Handle**
Ref. T470-FA

Stand
Ref. HD-SE

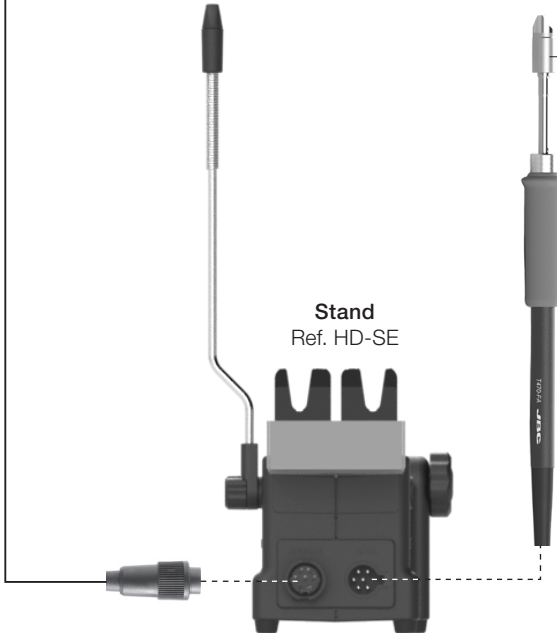

Features



Peripherals

Join the station port with 1 module and 1 pedal. See the compatible peripherals below:

Nitrogen Flow Regulator
Ref. MNE-A



Pedal
Ref. P-005



Fume Extractor Switch
Ref. FSE-A



Pedal
Ref. P-005



Use this foot switch to **enable/disable** a module or make the tool enter/exit **Sleep** mode. If you do not have a module, you can link up the P-305 Pedal Kit to the tool port.

HDE Work Screen

The HDE offers an intuitive user interface which provides quick access to station parameters.

Default PIN: 0105

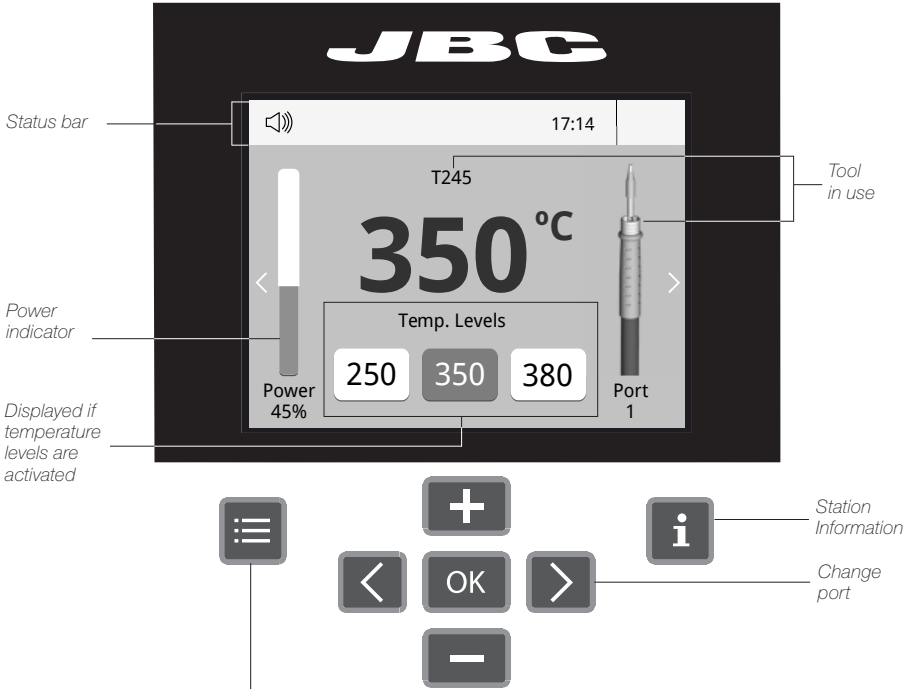

Menu Options



Set the station parameters

Station

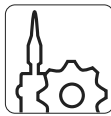

Set the tool parameters

Tools



Display the hours worked in each cycle

Counters



Consult / modify the links of the peripherals connected to the station with the port they are connected to.

Peripherals



It is possible to choose the language from a list.

Language



Allows you to carry out an overall station reset restoring all the parameters to their default values.

Reset

Troubleshooting

Station troubleshooting available on the product page at www.jbctools.com

Advanced functionalities



Graphics

It provides detailed graphics of tip temperature and power delivery in real time during solder joint formation for analysis purposes. This helps you decide how to adjust your process or which tip to use to obtain the best quality soldering.



Profiles

Designed to avoid thermal shock when soldering Ceramic Chip components like MLCC, this new and unique feature allows controlling the heating ramp up rate of the tool to gradually increase the temperature of the component through all the phases of the soldering process. Up to 25 fully configurable soldering profiles can be stored.

JBC Net

The first system to optimize traceability in soldering

- Get greater quality and control in your production
- Manage your whole soldering process remotely in real time

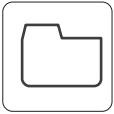

Files

Export graphics

Insert a USB flash drive into the USB-A connector to save your soldering process in csv format.



Update

Station update

Download the JBC Update File from www.jbctools.com/software.html
Insert the USB flash drive with the file downloaded to the station.



System notifications

The following icons will be displayed on the screen's status bar.



USB flash drive is connected.



Station is controlled by a PC.



Station is controlled by a robot.



Station software update.
Press INFO to start the process.



Warning.
Press INFO for failure description.



Error.
Press INFO for failure description,
the type of error and how to proceed.

Soldering Net

Remotely manage and monitor as many stations as your Windows PC can handle.

1. Download the **JBC Software Manager** and the user manual from jbcnet.solutions
2. Connect the stations via USB-B connector and the PC will automatically detect them.
3. The notification  will be displayed on the station.

Functions:

- Set all the station parameters from your PC.
- Organize groups of stations and set all their parameters at the same time.
- Store specific configurations for later uses.
- Analyze the soldering graphics of the stations on your PC and export them.

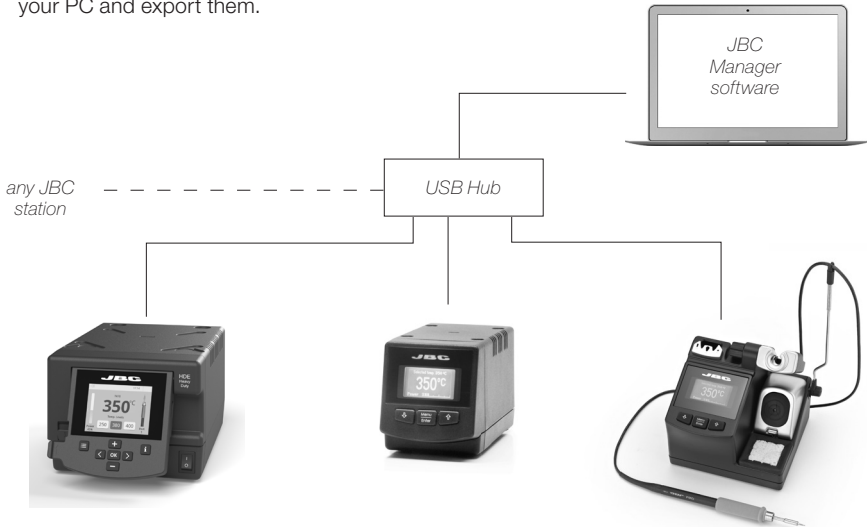

Operation

The JBC Most Efficient Soldering System

Our revolutionary technology is able to recover tip temperature extremely quickly. It means the user can work at a lower temperature and improve the quality of soldering. The tip temperature is further reduced thanks to the Sleep and Hibernation modes which increase up to 5 times the life of the tip.

1. Work

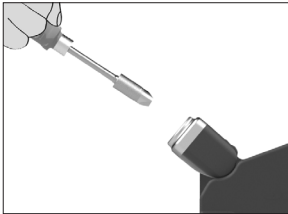

When the tool is lifted from the stand the tip will heat up to the selected temperature.



2. Sleep

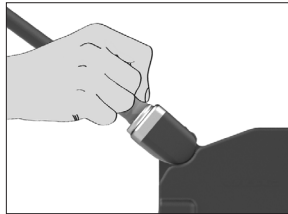

When the tool is in the stand, the temperature falls to the preset Sleep temperature.



3. Hibernation

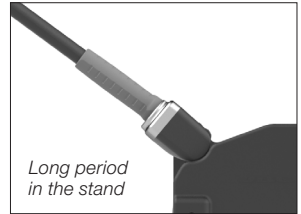

After longer periods of inactivity, the power is cut off and the tool cools down to room temperature.

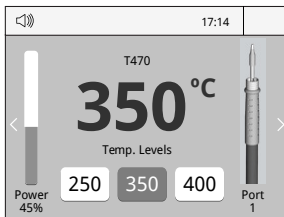

Tools Menu:

- Set temperature limits
- Select temperature levels



Tools Menu:

- Set Sleep temperature
- Set Sleep delay (from 0 to 9 min or no Sleep)

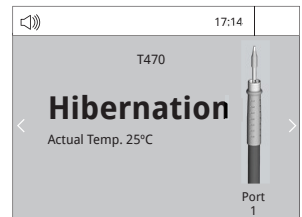

Tools Menu:

- Set Hibernation delay (from 0 to 60 min or no hibernation)

Stand

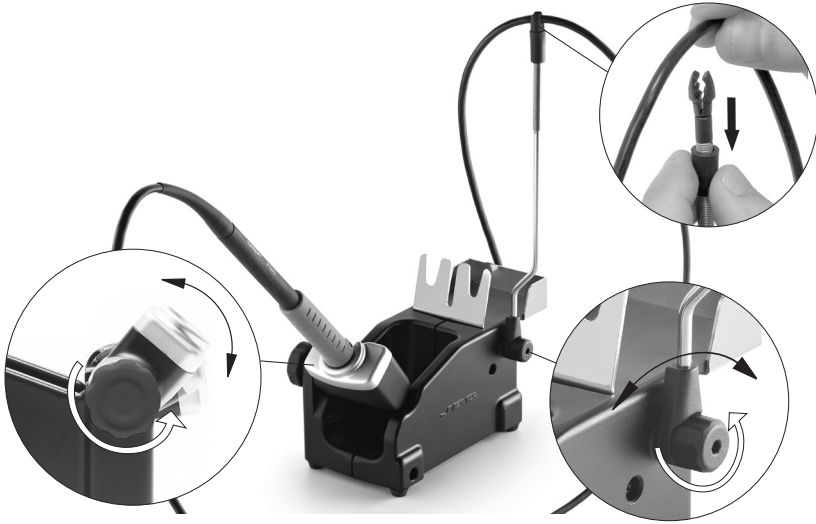

Changing Cartridges

1. Removing

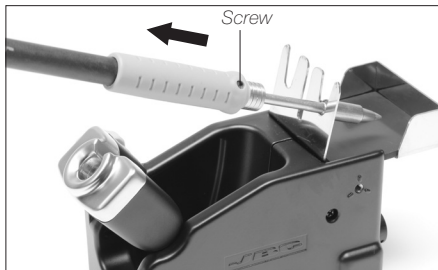

Loosen the screw. Place the Soldering Iron in the extractor and remove the cartridge.

2. Inserting

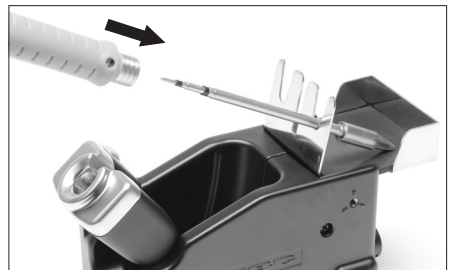

Insert the cartridge and press slightly to the mark*.

3. Fixing

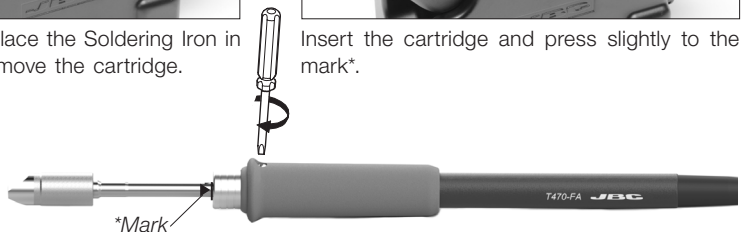

Once the cartridge is properly inserted we recommend tightening the screw to prevent it turning.
⚠ Important: It is essential to insert the cartridges as far as the mark for a proper connection.

Compatible Tools

T470 Handles for Heavy Duty

For intensive soldering jobs requiring continued high thermal power. They feature a non-slip-grip with a good thermal insulation and a screw which fixes the cartridge and prevents rotation.

Standard HD Iron with anti-slip grip

Ref. T470-A 1,5m (4.9ft) cable

Ref. T470-SA 3m (9.8ft) cable



Thermal Insulator HD Iron with soft grip

Ref. T470-FA 1,5m (4.9ft) cable

Ref. T470-MC 3m (9.8ft) cable

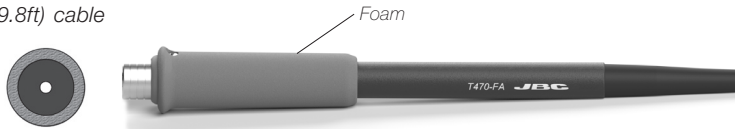

Tri-lobed HD Iron with anti-slip grip

Ref. T470-ZA 1,5m (4.9ft) cable

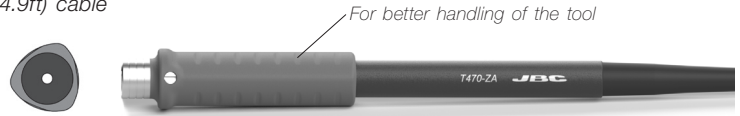

Nitrogen HD Iron with anti-slip grip

Ref. T470-NA 1,5m (4.9ft) cable

The MNE Nitrogen Flow Regulator is required. Only used with a DN-SE stand.

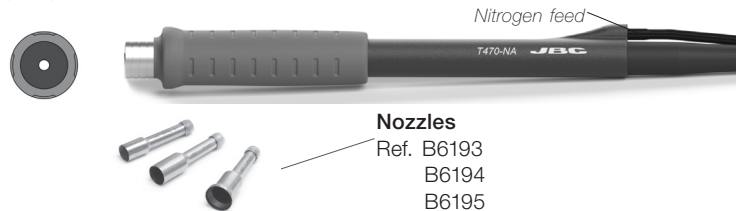

HD Thermal Tweezers

Ref. HT470-A

Only used with two HIDE-D control units and a HDT-SD stand.



Use C470 Cartridge range.

Find the model that best suits your soldering needs in www.jbctools.com

Tip Cleaner

Improve thermal transfer by cleaning the tip after each solder joint.

Brass wool

Ref. CL6210

Very effective cleaning method. It leaves a small layer of solder on the tip to prevent oxidation between cleaning and reflowing.

Splashguard

Ref. 0017576

It prevents splashing of solder particles when using the brass wool.

Antisplash Membrane

Ref. 0017574

Prevents splashing to maintain the work area clean.

ESD Tip Wiper

Ref. CL0240

A temperature resistant receptacle lets the operator remove excess solder by gentle tapping or wiping.

Sponge

Ref. S0354

The least harmful cleaning method. Keep the sponge damp with distilled water when working to avoid tip wear.

Non-slip base

No need to hold the base while cleaning tips.



Tapping:

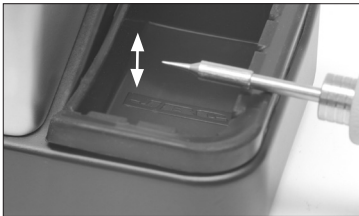

Tap to remove excess solder.

Wiping:

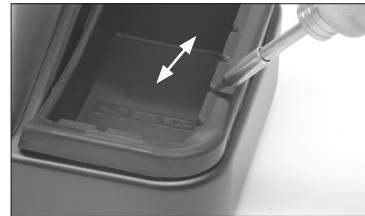

Use the slots to remove remaining particles.

Maintenance

Before carrying out maintenance, always allow the equipment to cool.

- Clean the station screen with a glass cleaner or a damp cloth.
- Use a damp cloth to clean the casing and the tool. Alcohol can only be used to clean the metal parts.
- Periodically check that the metal parts of the tool and stand are clean so that the station can detect the tool status.
- Maintain tip surface clean and tinned prior to storage in order to avoid tip oxidation. Rusty and dirty surfaces reduce heat transfer to the solder joint.
- Periodically check all cables and tubes.
- Replace a blown fuse as follows:

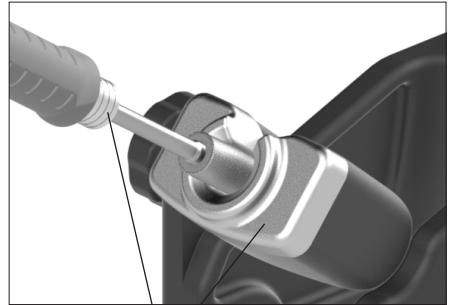

Clean periodically

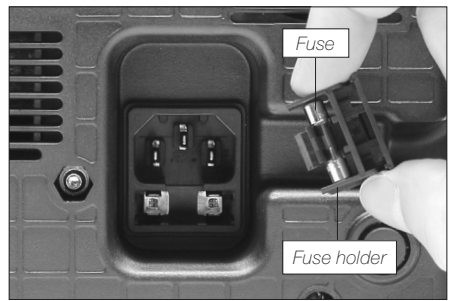
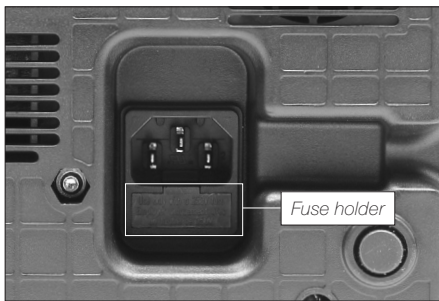

1. Pull off the fuse holder and remove the fuse. If necessary use a tool to lever it off.

2. Press the new fuse into the fuse holder and replace it in the station.

- Replace any defective or damaged pieces. Use original JBC spare parts only.
- Repairs should only be performed by a JBC authorized technical service.

Safety



It is imperative to follow safety guidelines to prevent electric shock, injury, fire or explosion.

- Do not use the units for any purpose other than soldering or rework. Incorrect use may cause fire.
- The power cord must be plugged into approved bases. Be sure that it is properly grounded before use. When unplugging it, hold the plug, not the wire.
- Do not work on electrically live parts.
- The tool should be placed in the stand when not in use in order to activate the sleep mode. The soldering tip, the metal part of the tool and the stand may still be hot even when the station is turned off. Handle with care, including when adjusting the stand position.
- Do not leave the appliance unattended when it is on.
- Do not cover the ventilation grills. Heat can cause inflammable products to ignite.
- Avoid the contact of flux with skin or eyes to prevent irritation.
- Be careful with the fumes produced when soldering.
- Keep your workplace clean and tidy. Wear appropriate protection glasses and gloves when working to avoid personal harm.
- Utmost care must be taken with liquid tin waste which can cause burns.
- This appliance can be used by children over the age of eight and also persons with reduced physical, sensory or mental capabilities or lack of experience provided that they have been given adequate supervision or instruction concerning use of the appliance and understand the hazards involved. Children must not play with the appliance.
- Maintenance must not be carried out by children unless supervised.

有害物质含量表

产品中有害物质的名称及含量

部件名称	有害物质					
	铅(Pb)	汞(Hg)	镉(Cd)	六价铬(Cr(VI))	多溴联苯(PBB)	多溴二苯醚(PBDE)
烙铁头	0	0	0	0	0	0
手柄	0	0	0	0	0	0
电源线	0	0	0	0	0	0
主机	0	0	0	0	0	0
电源插座	0	0	0	0	0	0
保险丝	0	0	0	0	0	0
主开关	0	0	0	0	0	0
电位连接	X	0	0	0	0	0
变压器	0	0	0	0	0	0
线路板	X	0	0	0	0	0

0 表示该有害物质在该部件所有均质材料中的含量均在GB/T 26572 规定的限量要求以下。
X 表示该有害物质至少在该部件的某一均质材料中的含量超出GB/T 26572 规定的限量要求。

Specifications

HDE-1D 120V 50/60Hz. Input fuse: 4A. Output: 42V.

HDE-2D 230V 50/60Hz. Input fuse: 2A. Output: 42V.

HDE-9D 100V 50/60Hz. Input fuse: 4A. Output: 42V.

- Temperature Range: 90 - 500 °C (190 - 932 °F)
- Idle Temp. Stability (still air): ± 1.5 °C / ± 3 °F
- Output Peak Power: 250W
- Tip to ground resistance: < 2 ohms
- Tip to ground voltage: < 2mV RMS
- Ambient operating temp: 10 - 50 °C (50 - 122 °F)
- Connections: USB-A / USB-B / Peripherals connectors
RJ12 connector for Robot
- Control Unit Weight: 4,9 kg (10.8 lb)
- Control Unit Dimensions: 148 x 232 x 120 mm (5.8 x 9.1 x 4.7 in)

- Total Package: 368 x 368x 195 mm / 6,23 kg
14.5 x 14.5 x 7.7 in / 13.73 lb

Complies with CE standards.

ESD protected housing.

JBC

Warranty

JBC's 2 year warranty covers this equipment against all manufacturing defects, including the replacement of defective parts and labour.

Warranty does not cover product wear or misuse.

In order for the warranty to be valid, equipment must be returned, postage paid, to the dealer where it was purchased.

Get 1 extra year JBC warranty by registering here:
<https://www.jbctools.com/productregistration/>
within 30 days of purchase.



This product should not be thrown in the garbage.

In accordance with the European directive 2012/19/EU, electronic equipment at the end of its life must be collected and returned to an authorized recycling facility.



www.jbctools.com