



## **KC Series 4-Channel Programmable Power Supply User Manual**

SHENZHEN KORAD TECHNOLOGY CO., LTD.

Address: F9, Building D2, Kechuang Center, Songshan Lake Intelligent Valley,  
No. 7 Yanhe North Road, Liaobu Town, Dongguan City, Guangdong Province.

Tel: 86-769-81111584 Fax: 86-769-81111804

E-mail: [krissy@koradtechnology.com](mailto:krissy@koradtechnology.com)

[www.koradtechnology.com](http://www.koradtechnology.com)

[www.korad.com.cn](http://www.korad.com.cn)

## Table of Contents

Production Introduction.....	1
Specifications and Series.....	1
Main Features.....	1
Front Panel Introduction.....	2
Real Panel Introduction.....	3
Power Output Mode.....	4
Operation Instructions.....	5
Keyboard Function.....	5
Set constant voltage, constant current and output.....	7
Static storage/recall function.....	7
OVP Function.....	8
OCP Function.....	8
Switch between static mode and LIST mode.....	8
Set and modify the LIST value.....	9
Oscilloscope Function.....	9
U disk data import and export function.....	10
Keyboard LOCK Function.....	11
System Configuration.....	11
Parameters Table.....	13

## Product Introduction

### Specifications and Series

Model	Output Voltage	Output Current	Output Power
KC3405	0-30V *4	0-5A*4	600W
KC6403	0-60V*4	0-3A*4	720W

### Main Features

- Four independent output channels
- LIST programmable output sequence, 100 consecutive different settings
- LIST mode and normal mode can be switched automatically with one button
- Oscilloscope function for simultaneous display of voltage and current on four channels
- Oscilloscope screen capture via USB access to U disk
- U disk import and export output table data, and you can edit it by computer EXCEL
- Low chopping and low noise
- High resolution and precision with 5-digit display
- Remote measurement function
- External trigger control and switch control
- Supporting OVP, OCP and temperature protection
- Built-in USB/RS232/GPIB/LAN communication interfaces

Temp. Coefficient		
Voltage	≤150ppm	≤150ppm
Current	≤150ppm	≤150ppm
Read Back Temp. Coefficient		
Voltage	≤150ppm	≤150ppm
Current	≤150ppm	≤150ppm
Accessories		
User manual*1, Power cord*1, CD*1, USB cable * 1, RS232 cable * 1, 10A test leads * 4		
Weight and Dimension(mounting dimension, including the machine feet)		
430mm(W)*94mm(H)*450mm(D); KC3405x18.5kg & KC6403x19.8kg		

## Parameters Table

<b>Models</b>	KC3405	KC6403
<b>Power</b>	600W	720W
<b>Voltage</b>	0-30V*4	0-60V*4
<b>Current</b>	0-5A*4	0-3A*4
<b>Load Regulation</b>		
Voltage	≤3mv	≤3mv
Current	≤1mA	≤1mA
<b>Line Regulation</b>		
Voltage	≤0.01%+3mv	≤0.01%+3mv
Current	≤0.05%+3mA	≤0.05%+3mA
<b>Setup Resolution</b>		
Voltage	1mV	1mV
Current	0.1mA	0.1mA
<b>Read Back Resolution</b>		
Voltage	1mV	1mV
Current	0.1mA	0.1mA
<b>Setup Accuracy (25°C ±5°C)</b>		
Voltage	≤0.05%+3mv	≤0.05%+3mv
Current	≤0.05%+2mA	≤0.05%+2mA
<b>Ripple (20-20M)</b>		
Voltage	≤1mVrms	≤1mVrms
Current	≤5mVrms	≤5mVrms
<b>Voltage Rise Time</b>		
Voltage	≤90ms	≤90ms
Current	≤90ms	≤90ms

## Front Panel Introduction

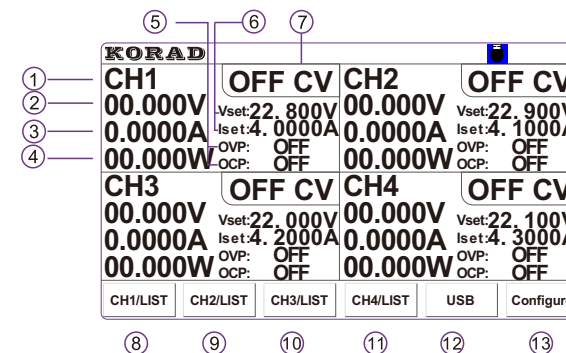
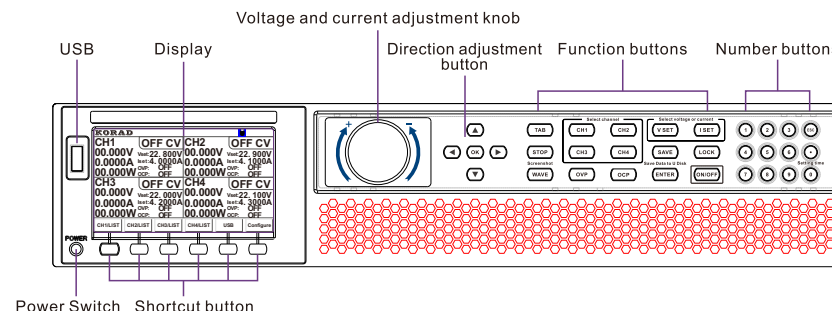

- ① CH1 channel indication, refers to the constant output mode of the channel. When entering the output mode of dynamic LIST, it becomes LIST-1.
- ② Output voltage indication, refers to the actual output voltage value of CH1.
- ③ Output current indication, refers to the actual output current value of CH1.
- ④ Output power indication, refers to the actual output power value on CH1.
- ⑤ OVP and OCP setting and switch status, when OCP and OVP are OFF, it shows OFF while it indicates the set value when OVP and OCP are ON.
- ⑥ CH1 set value of voltage and current.
- ⑦ Output ON/OFF indication, and constant voltage and constant current mode indication of channel output.
- ⑧ CH1 constant output and button indication of dynamic LIST output.
- ⑨ CH2 constant output and button indication of dynamic LIST output.
- ⑩ CH3 constant output and button indication of dynamic LIST output.

- ⑪ CH4 constant output and button indication of dynamic LIST output.
- ⑫ USB flash disk insertion indication. When the USB flash disk is inserted, the logo will appear as a USB font.
- ⑬ System configuration and button indication of function configuration.

## Rear Panel Introduction

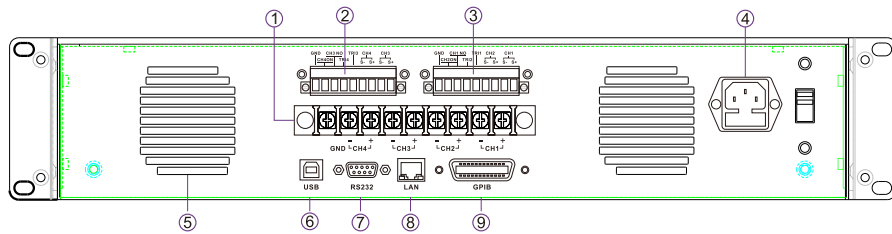

- ① 4 channel voltage output terminals, GND is the earth terminal
- ②-③ External control port, as shown below:

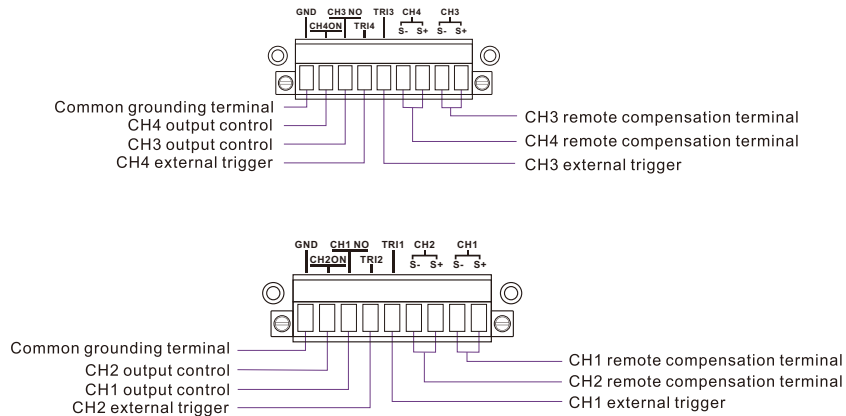

- ④ AC power input port
- ⑤ Vent
- ⑥ USB communication port
- ⑦ RS232 communication port

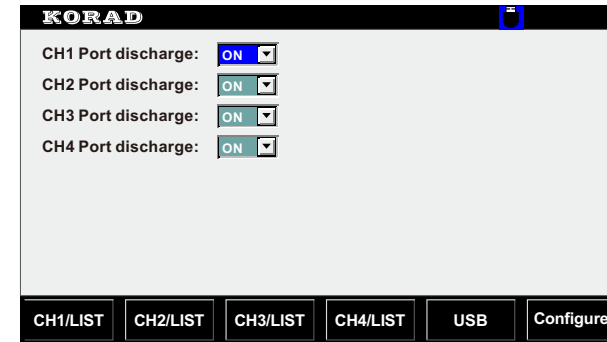

2. After entering USB mode, the file directory box on the left automatically displays all the files with CSV extension in the USB flash drive. The right side is divided into import LOAD of U disk data and export SAVE of disk data.
3. Through Left and Right, you can switch between the directory box, LOAD channel selection and selection box of storage data.
4. With UP and DOWN, you can switch from SAVE box to LOAD box.
5. Edit the file name with the number buttons.
6. Set the data, and when the cursor is in the LOAD box, press the ENTER button to save the data from the U disk to the power storage. When the cursor is in the SAVE box, the file can be saved on the U disk.
7. SAVE: as long as a U disk is inserted, long press to take a screenshot to the U disk.

## 10. Keyboard LOCK Function

Press and hold the button LOCK to lock the keyboard, and press and hold again to unlock.

## 11. System configuration

- 11.1 Press Configure to enter the configuration interface.
- 11.2 Press the button TAB to switch to the item you need to modify.
- 11.3 In the setting, use the numeric keyboard to modify the input field, and use the UP/DOWN key or knob to select the field to modify.
- 11.4 Press Configure again to save and exit the configuration interface.

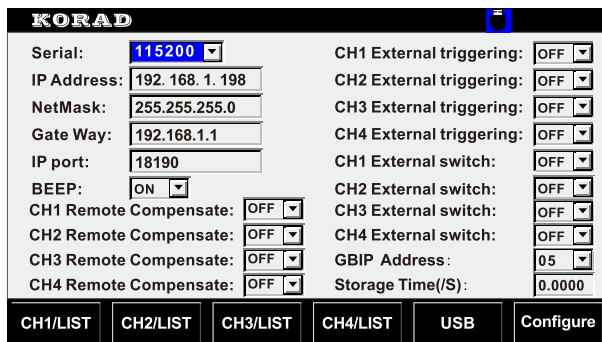

- ⑧ LAN communication port
- ⑨ GPIB communication port

## Power Output Mode

The power output is divided into two ways, constant output and output of dynamic LIST mode.

Constant output is constant voltage or constant current output. Dynamic LIST output, that is, the output can output according to the time sequence output of the set voltage and current.

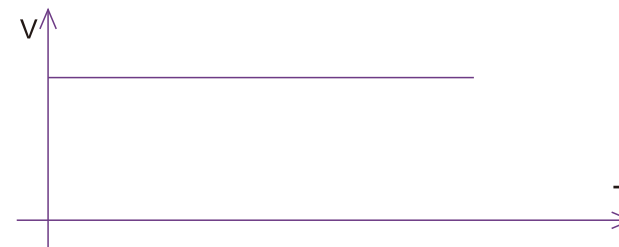

Constant mode output

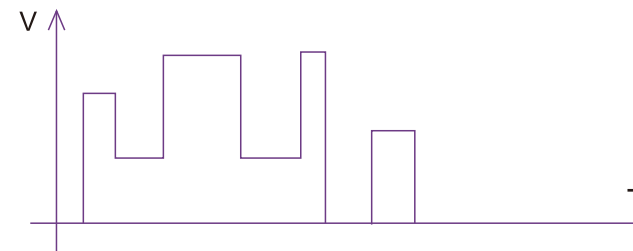

Dynamic output mode

# Operation Instructions

1. Keyboard functions
2. Voltage and current settings
3. Static storage / recall function
4. OVP function
5. OCP function
6. Switch between static mode and LIST mode, LIST selection
7. Set and modify the LIST value
8. Oscilloscope function
9. U disk function
10. Keyboard lock function
11. System configuration

## 1. Keyboard Function

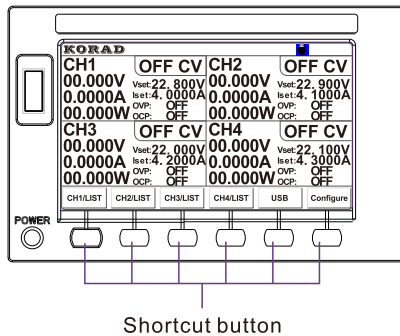

### 1.1 Quick-action button

- 1.1.1 CH1/LIST-CH4/LIST Button, entering LIST editing mode of CH1-CH4
- 1.1.2 USB button, data import and export function button
- 1.1.3 System configuration button

2. CH1: OFF-CH4: OFF: select the voltage and current waveforms of the four channels to be displayed on the oscilloscope. And it can display 8 waveforms simultaneously at most.
3. F5: Select the item to be measured.
4. TAB: the oscilloscope scans or pauses.
5. UP: select the measurement line for the moving voltage, and adjust it with the knob to move up and down.
6. DOWN: select the measurement line of the moving current, and use the knob to move it up and down.
7. Left: select the timeline on the left and use the knob to move left or right.
8. Right: select the timeline on the right, and use the knob to move left or right.
9. VSET: select to adjust the amplitude of the voltage oscilloscope, and use the knob to zoom in and out.
10. ISET: select to adjust the amplitude of the current oscilloscope, and use the knob to zoom in and out.
11. OVP: select to adjust the oscilloscope waveform time to zoom in and out, and use the knob to adjust it.
12. OCP: after the waveform is enlarged, move the waveform to the left and adjust it with the knob to move.

## 9. U disk data import and export function

1. Insert the USB flash drive into the USB interface on the left of the display. And the USB plug-in symbol will be displayed on the display interface. At the same time, the shortcut key icon will change from a blank icon to , and press F5 to enter USB mode as shown.

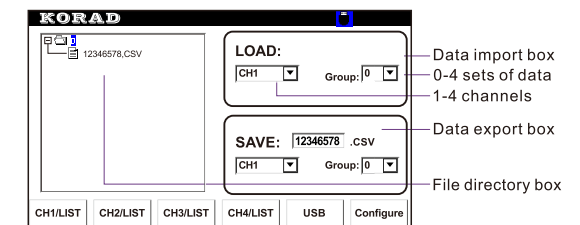
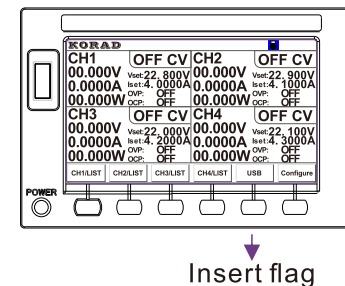

USB import and export interface

## 7. Set and modify the LIST value

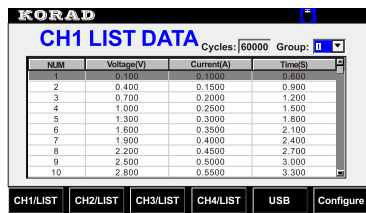

### 7.1 Modifying the existing content

1. Use the buttons CH1/List-CH4/List to enter the LIST list
2. Press the key TAB to switch the cursor from Group to LIST
3. Use the knob or UP/DOWN buttons to select the directory line to be modified
4. Press the OK button, and the red voltage table indicates that the contents of the voltage table can be modified.
5. Press Left/Right to cycle through the voltage, current, and time tables.
6. Modify the required content via the numeric keypad.
7. Press OK/ENTER to confirm the changes.
8. Press SAV button to save the changes.

### 7.2 Clear the existing values

1. Use the knob or UP/DOWN button to select the directory line to be cleared, and then press ESC to clear the current line and later contents.
2. Press SAV button to save the changes

**Note:** it is not only the current line that is cleared, but also the contents of all lines after this line.

## 8. Oscilloscope Function

1. Press the oscilloscope button on the main interface to enter the oscilloscope function interface.

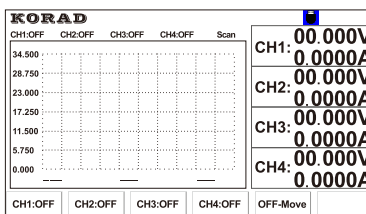

## 1.2 Use of Keyboard

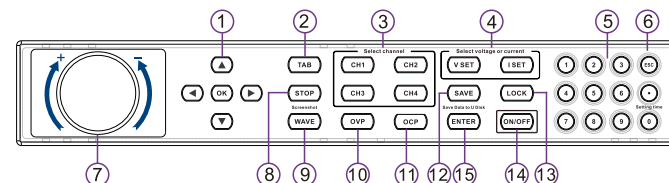

- ① Direction control keys are used to switch the selected target, or press the up key during the data operation to increase one digit of data, and press the down button to decrease one digit of data; press continuously and the data can be continuously increased or decreased.
- ② TAB: switch to the next editing project.
- ③ CH1-CH4: channel selection keys, used to select the channel to be operated.
- ④ VSET, ISET: buttons for selecting voltage settings or current settings.
- ⑤ Number setting keyboard.
- ⑥ Back or operation cancel button.
- ⑦ Data adjustment knob.
- ⑧ Stop button, to stop the oscilloscope display and other operations.
- ⑨ Oscilloscope function switching buttons.
- ⑩ Over-current protection setting button.
- ⑪ Over-voltage protection setting button.
- ⑫ Storage button.
- ⑬ Lock and unlock button.
- ⑭ Output ON or OFF button.
- ⑮ Confirmation button.



## 2. Set constant voltage, constant current and output

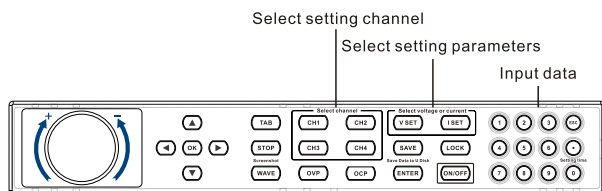

In the static mode, press the CH1-CH4 keys to select the channel to be modified; press the keys VSET/ISET to select the voltage or current to be modified, and then directly input the data parameters through the numeric keyboard. You can also modify the voltage and current by turning the knob. After setting, press ON/OFF for constant output.

## 3. Static storage/recall function

3.1 Static storage: store the current preset value in the selected storage space 0-9, which can be saved in four channels together or in a single channel.

3.1.1 Storage of four channels together: in the static mode, no channel is selected (if a channel is selected, press the key ESC to clear the selection); press SAV+numbers 0-9 to save to the corresponding storage space.

3.1.2 Saving a channel separately: using the keys CH1-CH4 to select the channel to be saved in the static mode, and then press SAV + numbers 0-9 to save the set value of the selected channel to the corresponding storage space.

3.2 Recall function: recall the static preset value of storage space 0-9, which can be recalled in four channels together or a single channel.

3.2.1 Recalling the four channels together: in the static mode, no channel is selected (if a channel is selected, press the key ESC to clear the selection); press and hold the numbers 0-9, then the data in the current storage space will be recalled.

3.2.2 Recalling a single channel: in the static mode, use the keys CH1-CH4 to select the channel to be recalled, and then press and hold the numbers 0-9 to recall the saved value of the selected channel to the corresponding channel.

## 4. OVP Function

### 4.1 OVP ON/OFF

In the static mode, use the keys CH1-CH4 to select the OVP channel to be ON/OFF; and then use the OVP button to switch the OVP status. OFF means to close OVP, and the OVP voltage display means to be ON.

### 4.2 Setting the OVP voltage

In the static mode, use the buttons CH1-CH4 to select the OVP channel to be set, and then use the OVP button to switch the OVP status to a status with voltage display. And adjust the OVP value through the Left/Right + UP/DOWN knobs, or directly enter the OVP by the Number keys + ENTER.

## 5. OCP Function

### 5.1 OCP ON/OFF

In the static mode, use the buttons CH1-CH4 to select the OCP channel to be ON/OFF, and then use the OCP button to switch the OCP status. OFF means the OCP is turned off, and the OCP current display means to be ON.

### 5.2 Setting the OCP current

In the static mode, use the buttons CH1-CH4 to select the OCP channel to be set, and then use the OCP button to switch the OCP status to the status with the current display. Use Left/Right + UP/DOWN knob to adjust the OCP value. And you can also complete the setting directly through the number buttons.

## 6. Switch between static mode and LIST mode

### 6.1 Switch between static mode and LIST mode

You can switch between the two modes by using the buttons CH1-CH4 in either the static mode or the LIST mode.

### 6.2 LIST selection

Use the buttons F1-F4 to enter the LIST list, and select the LIST list to be used by the rotary knob or UP/DOWN button. After selecting, press the buttons F1-F4 again to return,