

JBC

www.jbctools.com



Precision Hot Air Station

Ref. TESE-A

Packing List

The following items should be included:

TESE Control Unit1 unit
 Ref. TESE-1A (100V / 120V)
 TESE-2A (230V)



Stand1 unit
 Ref. TE-SE



Heater hose set1 unit
 Ref. TE-TB (100V / 120V / 230V)



Extractor desk1 unit
 Ref. 0008752*



Thermocouple Type K1 unit
 Ref. PH218



Power cable 1 unit
 Ref. 0009417 (100V / 120V)
 0009401 (230V)



TE Accessory set
 Ref. 0010300

Extractors* Ref. E2184 E2064 E2052	Tripod* Ref. T2050 (Ø 39mm) T2250 (Ø 85mm)	Suction Cups* Ref. 0930110 Ø 10 - 0934050 (x3) Ø 4.7 - 0934070 (x1)
Protectors* Ref. P2220 P2230 P2235 P4000 P4010	Suction Tube* Ref. 0932330	Nozzles Ref. TN9080 (x1) TN9208 (x1) TN9209 (x1)

Manual 1 unit
 Ref. 0019043



* Not supplied with TE-Q stations

Features

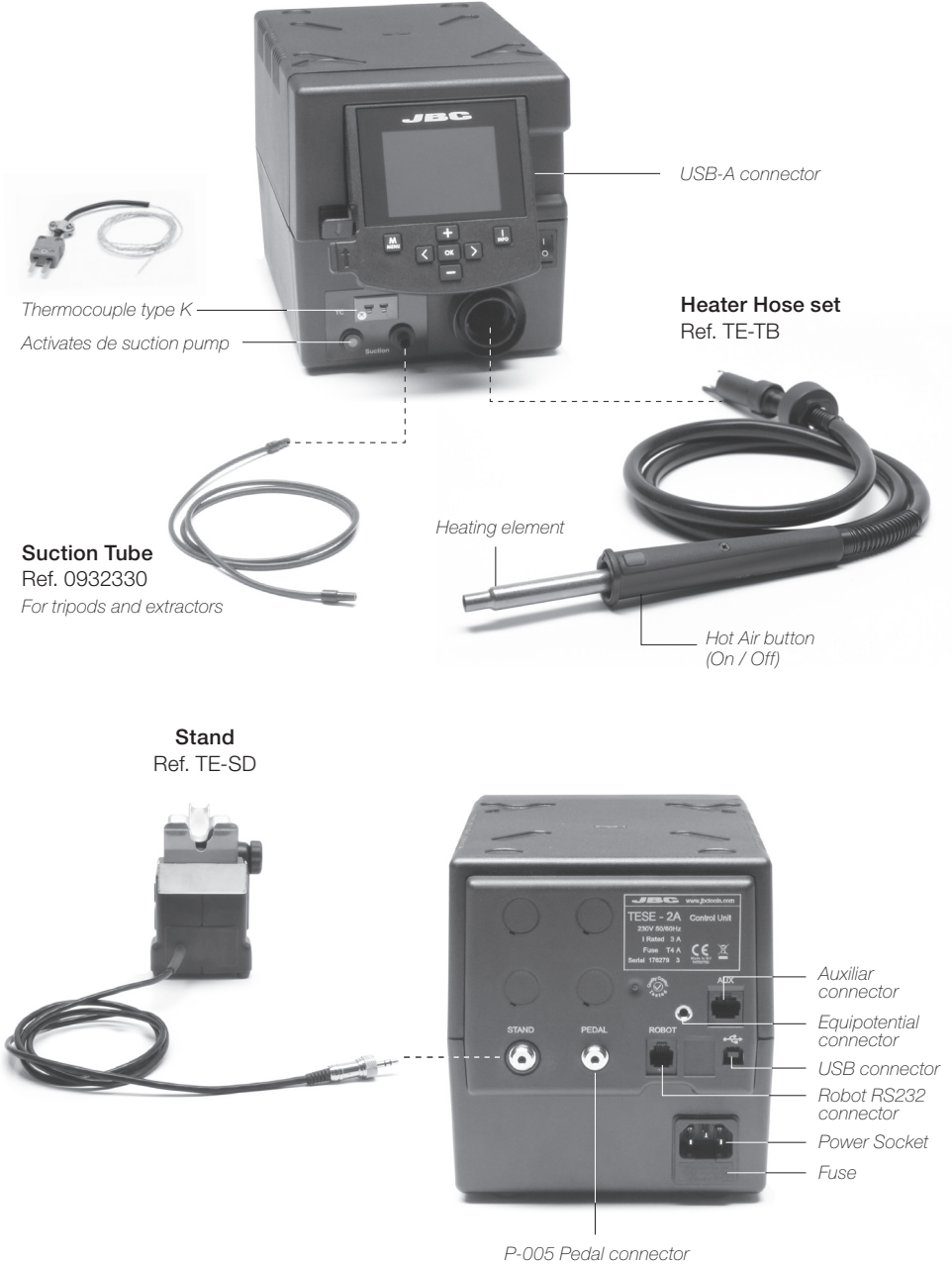

Quick Nozzle Changer

Changing nozzles quickly and safely.

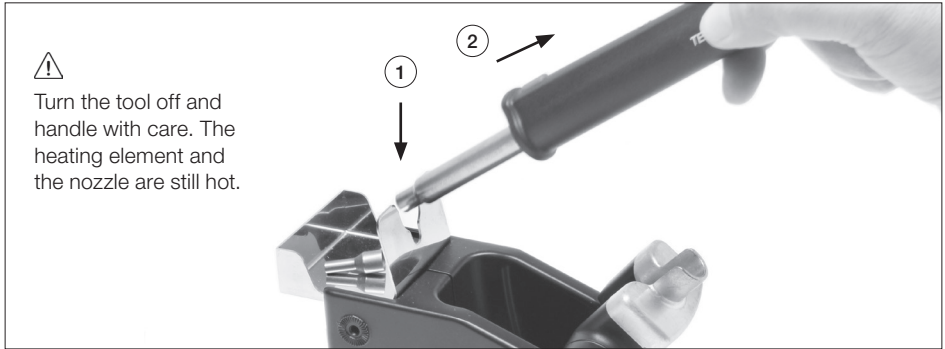

Changing the TE-TB Heater Hose Set

1. Ensure that the tool is turned off.
2. Use a spanner to unscrew the nut.
3. Make sure that the new heater tube fits into the grooves in the socket.
4. Tighten the screw.

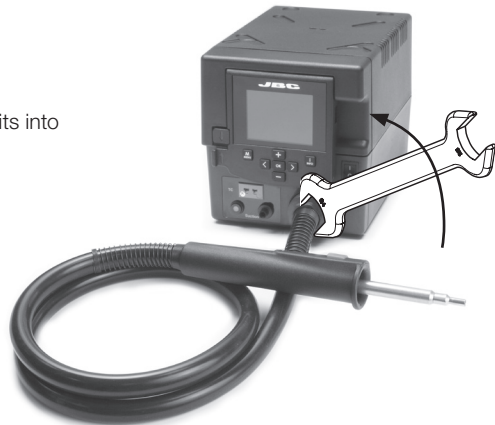

Operation

1. Placing

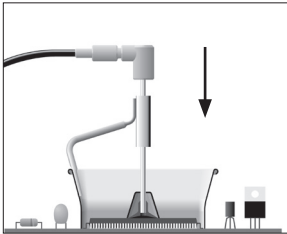

Position the extractor with the appropriate suction cup and press the suction button.

2. Heating

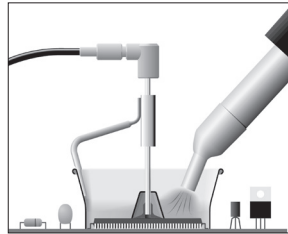

Heat the component.

3. Extracting

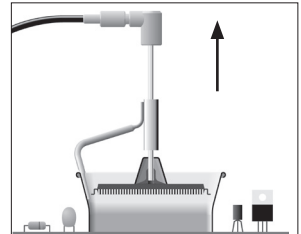

The component lifts off automatically when the solder melts.

Using the Thermocouple type K

Connect a TC type K (PH218) to the station and use it as a protection or regulation sensor. You can define its use mode by means of the “Ext TC mode” option in the “Tool” menu.

You can choose from **two work modes**:

Regulation: the station regulates the air temperature automatically to maintain the External Thermocouple (TC) temperature.

Protection: the station cuts the air supply off when the External Thermocouple (TC) temperature is reached.

Fix the TC with Kapton Tape (Ref. PH217) as near as possible to the component being worked on. If Kapton tape is not ESD you must use an ionizer.

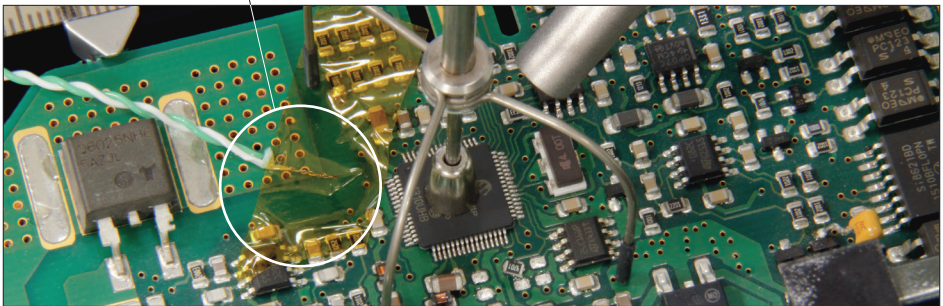

IPC* does not recommend exceeding ramp-up rates over 3 - 4 °C / sec (5 - 7 °F / sec) so as to reduce the risk of thermal stress on the PCB.

* IPC was founded in the U.S. in 1957 as the Institute for Printed Circuits.

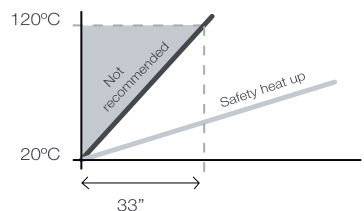

Process Control

The TESE offers an **intuitive user interface** which provides **quick access** to station parameters.
Original PIN: 0105

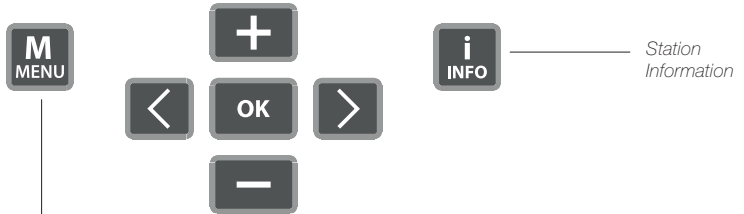
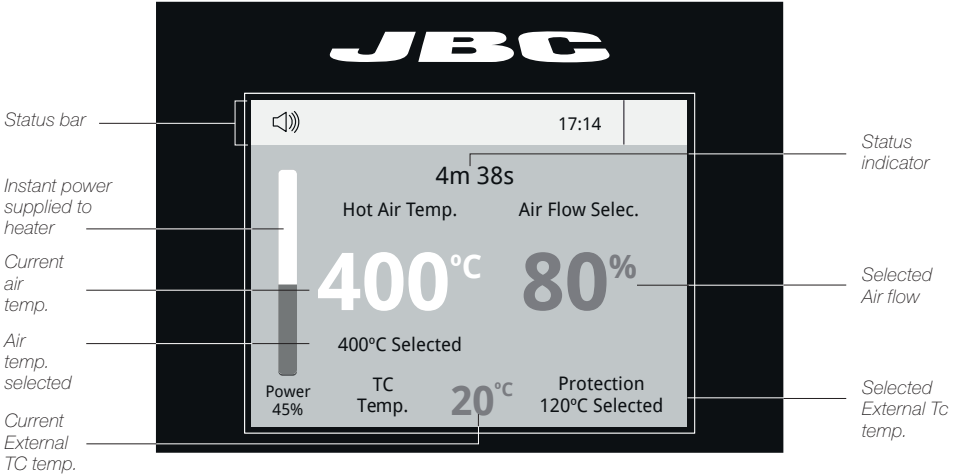

Menu Options

Press INFO for each parameter description.



Station



Tools



Profiles

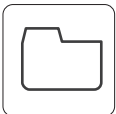

Files



Graphics



Reset

System notifications (Status Bar)

- USB flash drive is connected.
- Station is controlled by a PC.
- Station is controlled by a robot.
- Station software update.
Press INFO to start the process.
- Warning.
Press INFO for failure description.
- Error. Press INFO for failure description, the type of error and how to proceed.

Profiles



Profiles

In this mode you can **set up or edit** as many as 25 profiles of temperature and air flow.

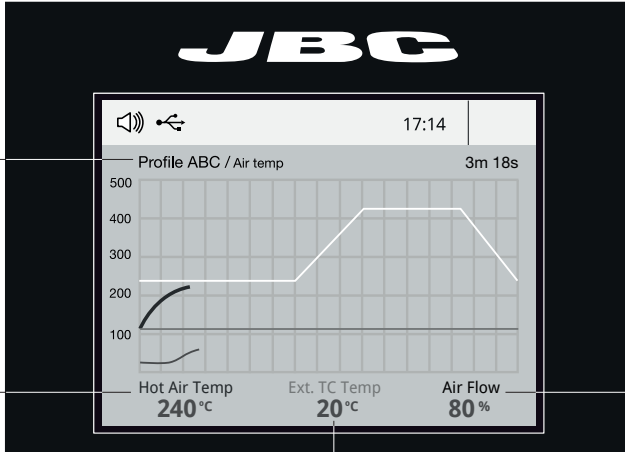

Profile name

Current air temp.

Current air flow

Current External TC temp.

Edit Mode

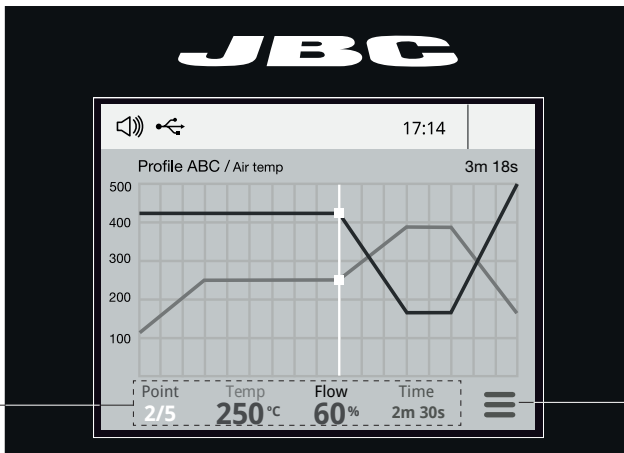

Data for these points

Menu Options

- Add point
- Delete point
- Load profile
- Save profile
- Exit

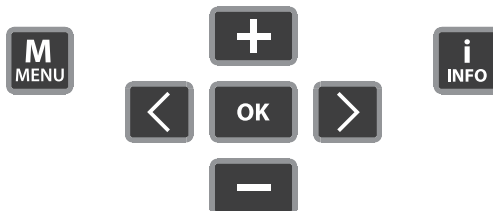

Process analysis



Graphics

By pressing **Graphics** in the main MENU, temperature and power figures in real time are displayed. This helps you decide which tip to use to obtain the best quality solder joints.

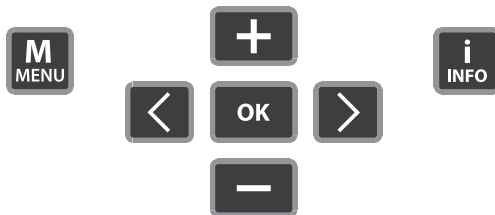
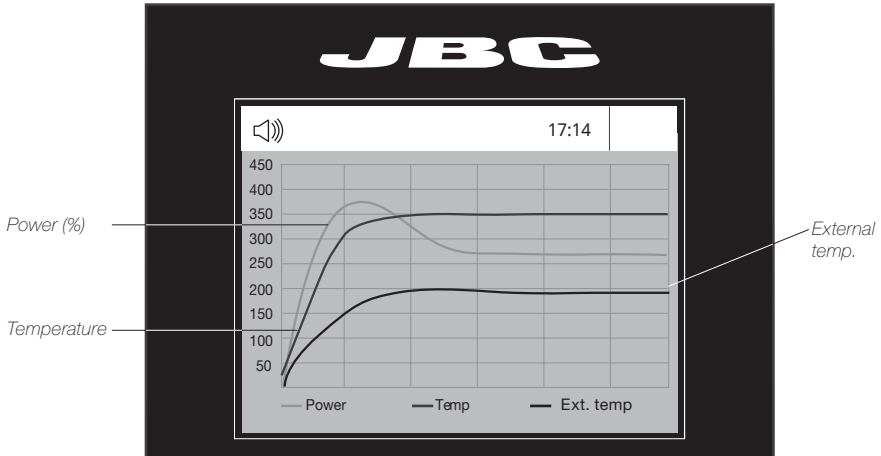

Files



Files

Export graphics

Insert a USB flash drive into the USB-A connector to save your soldering process in csv format.

Export / Import profiles

Insert a USB flash drive into the USB-A connector to export / import profiles.



JBC Net

Remotely manage and monitor your stations.

1. Download the **JBC Manager software** and the user manual from www.jbctools.com/manager.html
2. Connect the stations via USB-B connector and the PC will automatically detect them.
3. The notification  will be displayed on the station.

Functions:

- Set all the station parameters from your PC.
- Organize groups of stations and set all their parameters at the same time.
- Store specific configurations for later use.
- Analyze the soldering graphics of the stations on your PC and export them.

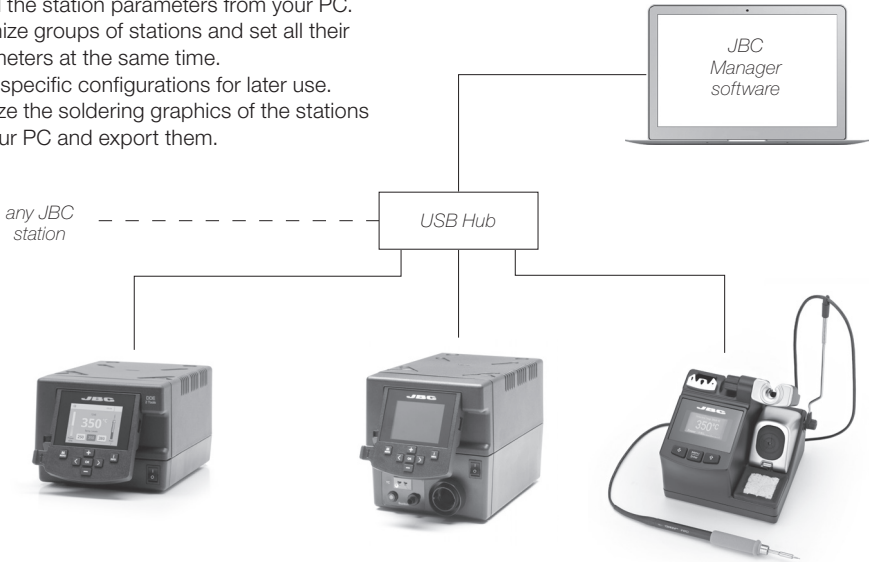

Update the station software

1. Download the JBC Update File from www.jbctools.com/software.html and save it on a USB flash drive. (Preferably one with no other files).

2. Insert the USB flash drive to the station. The icon  is displayed while updating.

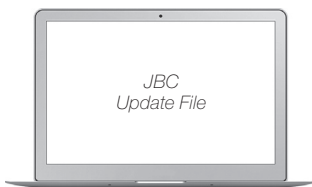

Hot Air Accessories

Find the model that best suits your soldering needs in www.jbctools.com

Protector



Tripod



Extractor



Manual extractor



For small components (fig. 1 and 2).
We recommend using the protector + tripod.

For big components (fig. 3 and 4).
We recommend using the extractor.

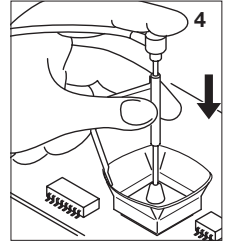
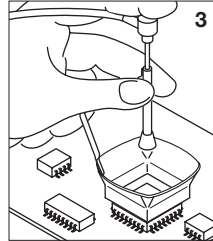
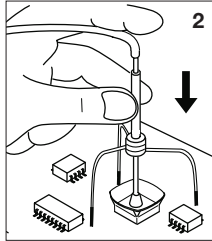
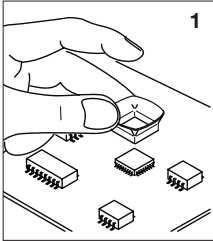

Extractor Desk

Ref. 0008752

This accessory lets you quickly switch between different models of extractors and protectors. There are two drawers for storage.



Maintenance

Before carrying out maintenance, always allow the equipment to cool.

- Clean the station screen with a glass cleaner or a damp cloth.
- Use a damp cloth to clean the casing and the tool. Alcohol can only be used to clean the metal parts.
- Periodically check that the metal parts of the tool and stand are clean so that the station can detect the tool status.
- Periodically check all cables and tubes.
- Replace a blown fuse as follows:

Clean periodically



1. Pull off the fuse holder and remove the fuse. If necessary use a tool to lever it off.

2. Insert the new fuse into the fuse holder and return it to the station.

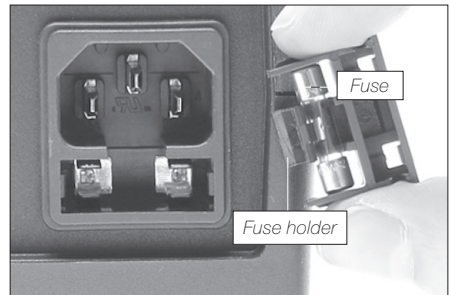
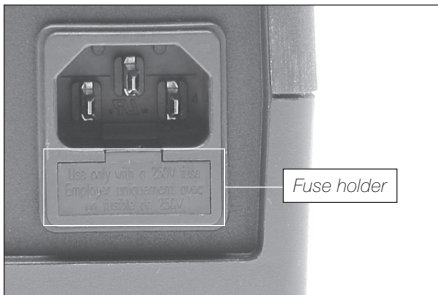

- Replace any defective or damaged pieces. Use original JBC spare parts only.
- Repairs should only be performed by a JBC authorized technical service.

Safety



It is imperative to follow safety guidelines to prevent electric shock, injury, fire or explosion.

- Do not use the units for any purpose other than soldering or rework. Incorrect use may cause fire.
- The power cord must be plugged into approved bases. Make sure that it is properly grounded before use. When unplugging it, hold the plug, not the wire.
- Do not work on electrically live parts.
- The tool should be placed in the stand when not in use to turn off the hot air. The soldering tip, the metal part of the tool and the stand may still be hot even when the station is turned off. Handle with care, including when adjusting the stand position.
- Do not leave the appliance unattended when it is on.
- Do not cover the ventilation grills. Heat can cause inflammable products to ignite.
- Avoid the contact of flux with skin or eyes to prevent irritation
- Be careful with the fumes produced when soldering.
- Keep your workplace clean and tidy. Wear appropriate protection glasses and gloves when working off to avoid personal harm.
- Utmost care must be taken with liquid tin waste which can cause burns.
- This appliance can be used by children over the age of eight and also persons with reduced physical, sensory or mental capabilities or lack of experience provided that they have been given adequate supervision or instruction concerning use of the appliance and understand the hazards involved. Children must not play with the appliance.
- Maintenance must not be carried out by children unless supervised.

有害物质含量表

产品中有害物质的名称及含量

部件名称	有害物质					
	铅(Pb)	汞(Hg)	镉(Cd)	六价铬 (Cr(VI))	多溴联苯 (PBB)	多溴二苯醚 (PBDE)
烙铁头	○	○	○	○	○	○
手柄	○	○	○	○	○	○
电源线	○	○	○	○	○	○
主机	○	○	○	○	○	○
电源插座	○	○	○	○	○	○
保险丝	○	○	○	○	○	○
主开关	○	○	○	○	○	○
电位连接	X	○	○	○	○	○
变压器	○	○	○	○	○	○
线路板	X	○	○	○	○	○

○ 表示该有害物质在该部件所有均质材料中的含量均在GB/T 26572 规定的限量要求以下。
 X 表示该有害物质至少在该部件的某一均质材料中的含量超出GB/T 26572 规定的限量要求。

Exploded View

TESE-1A 100/120V
TESE-2A 230V

PRECISION HOT-AIR STATION

SPARE PARTS	
TESE-1A / TESE-2A	
-ENCLOSURES:	
·TOP	0019028
·BOTTOM	0013486
·FRONT	0016862
·BACK	0016812
TESE-1A	
-CIRCUIT	0017185
-SUCTION PUMP	0008723
-HOT AIR PUMP	0015970
TESE-2A	
-CIRCUIT	0017671
-SUCTION PUMP	0008722
-HOT AIR PUMP	0015970

TESE-1A 100/120V FUSE T-8A
 TESE-2A 230V FUSE T-4A

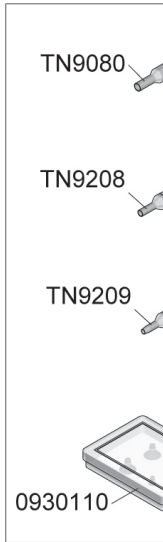

TESE-1A / TESE-2A

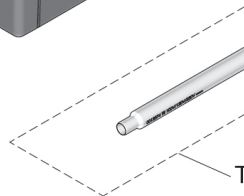
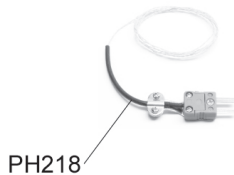

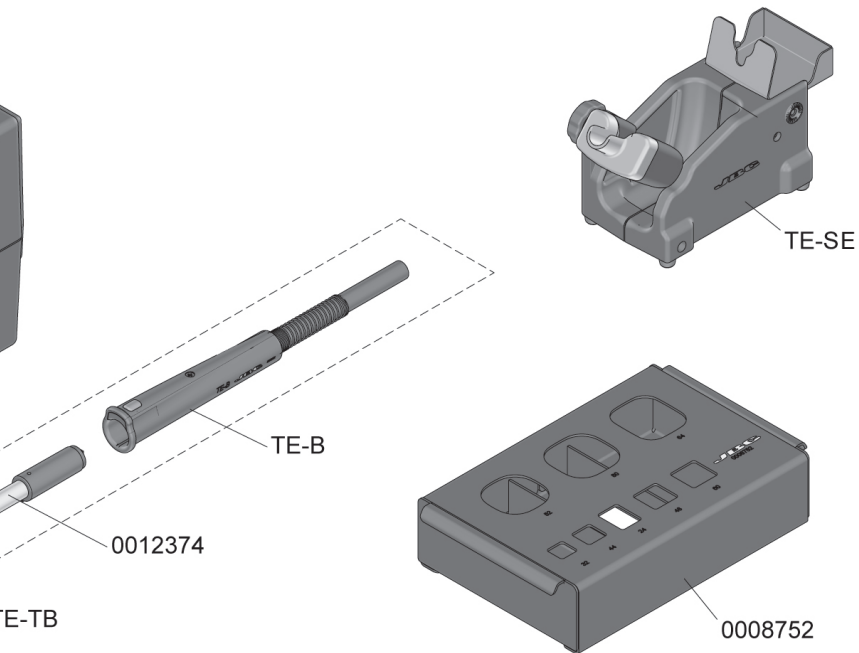
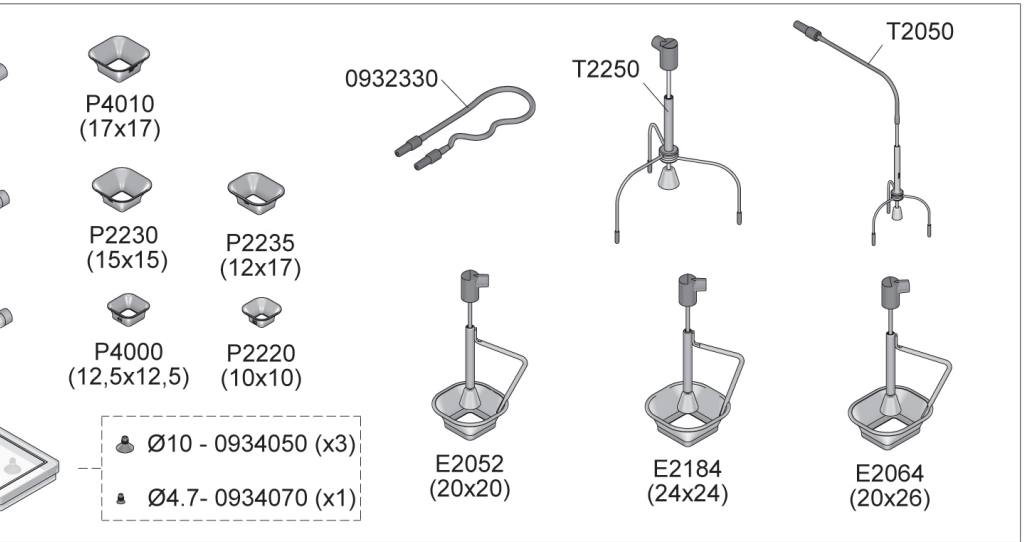

Specifications

TESE-1A 100V - 120V 50/60Hz. Input fuse: 8A. Rated current: 7A

TESE-2A 230V 50/60Hz. Input fuse: 4A. Rated current: 3A

- Weight: 4,7 kg (10.41 lb)
- Dimensions (control unit): 148 x 184 x 140 mm (5.83 x 7.24 x 5.51 in)
- Nominal power: 300W
- Temperature selection: Room temp. / 150 - 450 °C (300 - 840 °F)
Cool mode: temp. Off.
- Ambient operating temp: 10 - 40 °C (50 - 104 °F)
- Air flow regulation: 2 - 17 SLPM
- Vacuum: 30% / 228 mmHg / 9 inHg
- Connectors: USB station-PC
Robot RS232
P-005 Pedal

Complies with CE standards.
ESD protected.

JBC

Warranty

JBC's 2 year warranty covers this equipment against all manufacturing defects, including the replacement of defective parts and labour.

Warranty does not cover product wear or misuse.

In order for the warranty to be valid, equipment must be returned, postage paid, to the dealer where it was purchased.

Register your warranty within 30 days of purchase in www.jbctools.com/productregistration



This product should not be thrown in the garbage.

In accordance with the European directive 2002/96/EC, electronic equipment at the end of their life must be collected and returned to an authorized recycling facility.



Manual in other languages available on our website

www.jbctools.com