

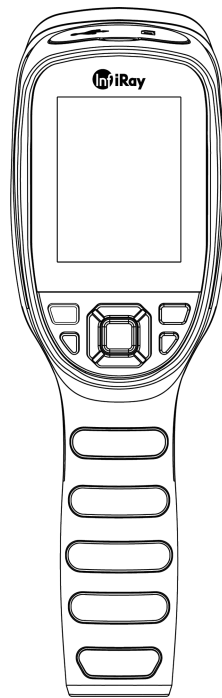

Tianshu C Series Handheld Thermal Camera User Manual V1.0.4



IRay Technology Co., Ltd.

www.infiray.com

Explore And Perceive The Future

Introduction to IRay Technology

IRay Technology concentrates on developing infrared thermal imaging technologies and manufacturing relevant products, with completely independent intellectual property rights. IRay is committed to providing global customers with professional and competitive infrared thermal imaging products and solutions. The main products include IRFPA detectors, thermal imaging modules, and terminal thermal cameras and imagers.

With R&D personnel accounts for 48% of all employees, 1760 intellectual property projects in terms of IRay have been authorized and accepted: 1099 patented technologies authorized and accepted in China (including those for integrated circuit chips, MEMS sensors design and manufacture, Matrix IV image algorithms and intelligent precise temperature measurement algorithms, etc.); 277 trade mark applications in China; 35 patents and patent applications overseas; 107 trade mark applications overseas; 191 software copyrights; and 51 integrated circuit layout designs. (The statistic data is up to August,2022)

IRay products have been applied in various fields, including industrial thermography, outdoor night vision observation, AI, machine vision, automatic driving, security and fire control, Internet of Things, and epidemic prevention and control.

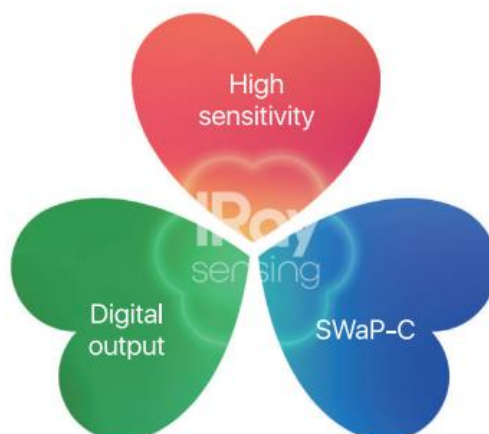

Table of Contents

1. Legal Disclaimer	1
1.1 Legal Disclaimer	1
1.2 Copyright	1
1.3 Quality Assurance	1
2. Safety Information	2
3. Notice to user	3
3.1 Calibration	3
3.2 Accuracy	3
3.3 Video Teaching	3
3.4 Documentation Updates	3
4. Customer Help	3
4.1 FAQ	3
4.2 Download	3
5. Comparison of Functions for Different Models	4
6. Camera Introduction	5
6.1 Camera	5
6.2 Buttons	6
6.3 Connector & Memory Card	7
7. Quick Start Guide	8
8. User Interface	9
9. Operating Instructions	10
9.1 Power On & Off	10
9.2 Saving Images	10
9.3 View / Delete Pictures	10
9.4 Center Spot Temperature Measurement	10
9.5 Cold/Hot Spot Tracing	11
9.6 User-defined Spot Measurement	11
9.7 Image Mode	11
9.7.1 Imaging Mode Introduction	11
9.7.2 Steps of Changing Image Modes	13
9.7.3 Color Palettes	13
9.8 Shutter Correction	13
9.8.1 Shutter Correction Introduction	13
9.8.2 Shutter Correction Operation	13
10. Settings	14
10.1 Measurement Parameters	14

10.1.1 Setting Emissivity	14
10.1.2 Setting Ambient Temperature	14
10.1.3 Setting Distance	14
10.2 Temperature Measurement Mode	14
10.3 High/Low Temperature Alarm	15
10.4 Photo-taking Settings	15
10.4.1 Automatically Save Photos	15
10.4.2 Time-lapsed Photo	15
10.5 Temperature Unit	15
10.6 Wi-Fi Settings	15
10.7 Auto Power-Off	15
10.8 System Settings	16
11.Application Scenarios	16
11.1 Warehouse Detecting	16
11.2 Detecting of Power Distribution Cabinet	17
11.3 Detecting of Heating Wire of Rear Car Window	18
11.4 HVAC Detecting	19
12.Structural Drawing	20
13.FAQ	21
14.Cleaning Thermal Camera	21
14.1 Cleaning Camera Housing, Cables and Other Items	21
14.2 Cleaning Infrared Lens	22

1. Legal Disclaimer

1.1 Legal Disclaimer

The thermal cameras manufactured by IRAY TECHNOLOGY are warranted for a period of two-year and the accessories are warranted for a period of three-month from the delivery date of the original purchase, provided such products have been under normal storage, use and maintenance.

This warranty extends only to the original purchaser and is not transferable. It is not applicable to any product which has been subjected to misuse, neglect, accident or abnormal conditions of operation.

In the case of a defect in a product covered by this warranty the product must not be further used or maintained in order to prevent additional damage. The purchaser shall promptly report any defect to IRAY TECHNOLOGY or this warranty will not apply.

IRAY TECHNOLOGY will, at its option, repair or replace any such defective product free of charge if, upon inspection, the product or accessories prove to be defective, the user can contact with after-sales service department of IRAY TECHNOLOGY within the said warranty period.

1.2 Copyright

©IRay Technology Co., Ltd. 2020. All rights reserved worldwide. All contents in this manual, including words, pictures, images, etc., belong to IRAY TECHNOLOGY CO., LTD. (Hereinafter referred to as "THE COMPANY" or "IRAY TECHNOLOGY"). No part of the manual, in whole or part, may be copied, photocopied, translated, or transmitted without the prior written permission of IRAY TECHNOLOGY.

This manual is used as a guide. The photos, graphics, diagrams and illustrations provided in the manual are only used to explain, which may be different from the specific product. The real product shall prevail. We try our best to make sure the contents in this manual are accurate. We do not provide any representations or warranties in this manual.

IRAY TECHNOLOGY reserve the right to update the manual. If you need the latest version of this manual, please contact us. It is recommended that you use this manual with the guidance of professionals.

1.3 Quality Assurance

The Quality Management System under which these products are developed and manufactured has been certified in accordance with the ISO9001 standard.

We reserve the right to make changes and improvements on any of the products without prior notice.

2.Safety Information

WARNING

1. Make sure you read all applicable Material Safety Data Sheets (SDS) and warning labels on containers before you use a liquid. The liquids can be dangerous. Injury to persons can occur.
2. It is prohibited to use the product in a high temperature above 85 °C or in a low temperature below-45 °C.
3. It is forbidden to disassemble or refit the thermal camera at will.
4. Do not use too long screws when installing the front/rear mounting bracket, which may damage the thermal camera.

CAUTION

1. No matter there is a lens cover or not, do not point the infrared thermal camera towards strong light or equipment with laser radiation. This will affect the accuracy of the thermal camera and even damage the detector in the thermal camera.
2. Do not use the product under conditions that doesn't match the environmental requirements. For specific use environment requirements, see the product parameter table.
3. Do not apply solvents or equivalent liquids to the camera, the cables, or other items.
4. Be careful when you clean the infrared lenses. The lens has an anti-reflective coating which is easily damaged. Damage to the infrared lens can occur with too much force or cleaning with rough objects such as tissues.

3. Notice to user

3.1 Calibration

IRAY TECHNOLOGY recommends that you verify your calibration yearly in order to ensure accuracy. You can verify the calibration through IRAY TECHNOLOGY or third-party organizations.

3.2 Accuracy

For very accurate results, we recommended that you wait 5 minutes after you have started the camera before measuring a temperature.

3.3 Video Teaching

You can search for mount and use videos from our website.

3.4 Documentation Updates

Our manuals are updated several times per year, and we also issue product-critical notifications of changes on a regular basis. Please visit our website to access the latest manuals and notifications.

4. Customer Help

4.1 FAQ

You can find answers to FAQ about this model on the service support page of our official website.

4.2 Download

You can download the following contents from our website: www.infiray.com

- Product Documentation
- Client Software
- Video Teaching Courses

5. Comparison of Functions for Different Models

Function	C200SE+	C200+	C200PRO+
Visual Resolution	/	200W	200W
Temperature Measurement Range	-20°C ~ +150°C 100°C ~ +400°C	-20°C ~ +150°C 100°C ~ +550°C	-20°C ~ +150°C 100°C ~ +550°C
Hotspot	/	/	Support
Video Transmission	/	UVC projection	UVC projection Wireless projection

6. Camera Introduction

6.1 Camera

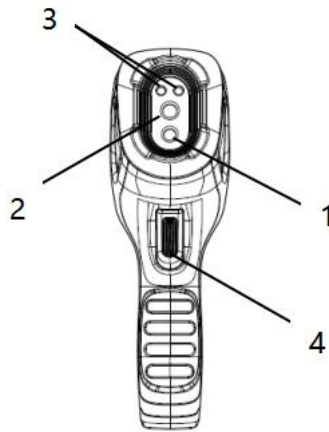

No.	Components
1	Digital Camera(optional)
2	Infrared Lens
3	LED lamp
4	Trigger (image/video capture)

Table 6.1 Component Introduction (View from the Front)

6.2 Buttons

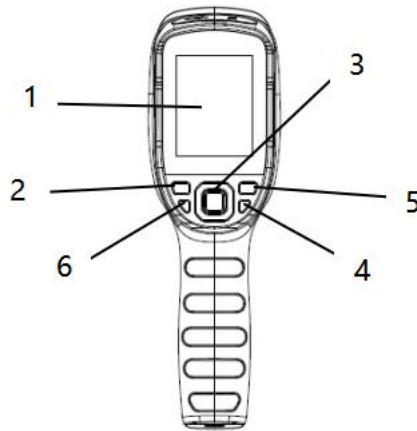

No.	Components	Function Description
1	Screen	
2	Gallery button	Click to open the archive images
3	Navigation button	<ul style="list-style-type: none"> ● Navigation and confirm; ● On the home screen, press the center button to call the main menu ● On the home screen, press the navigation button(left/right) to perform zoom in and zoom out
4	Power button	<ul style="list-style-type: none"> ● Calibrate on the home screen ● Back/exit
5	Back button	Press to cancel operation or back to previous menu.
6	LED lamp	Long press to turn on/off the LED lamp.

Table 6.2 Component Introduction (View from the Rear)

6.3 Connector & Memory Card

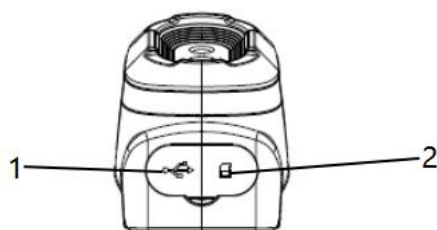

No.	Name	Description
1	USB slot	<ul style="list-style-type: none">● Connect the power adapter to charge via USB cable● Connect the computer to charge or transmit data via USB cable
2	SD card	<ul style="list-style-type: none">● Standard microSD card, 16GB by default, support up to 32GB● The microSD card can be removed to transmit data to PC or other equipment with card readers.

Table 6.3 Connector and Memory Card

7.Quick Start Guide

Please follow the procedures:

1.Charging:

- Please charge with 5V 1A or 5V 2A power adapter and USB cable.
- You can connect the PC with the USB cable to charge the device.
- Open the protective cover on the top of the device, and charge the device by connecting the USB Type-C connector with the PC or adapter via data cable.

2.Power on

Long press the power button  to turn on.

3.Point the camera at the object you are interested in.

4.Image Capture

Click the trigger to capture the image.

5.PC analysis

Download the client software, start client, import the data to perform the secondary analysis via USB cable or SD card.

8. User Interface

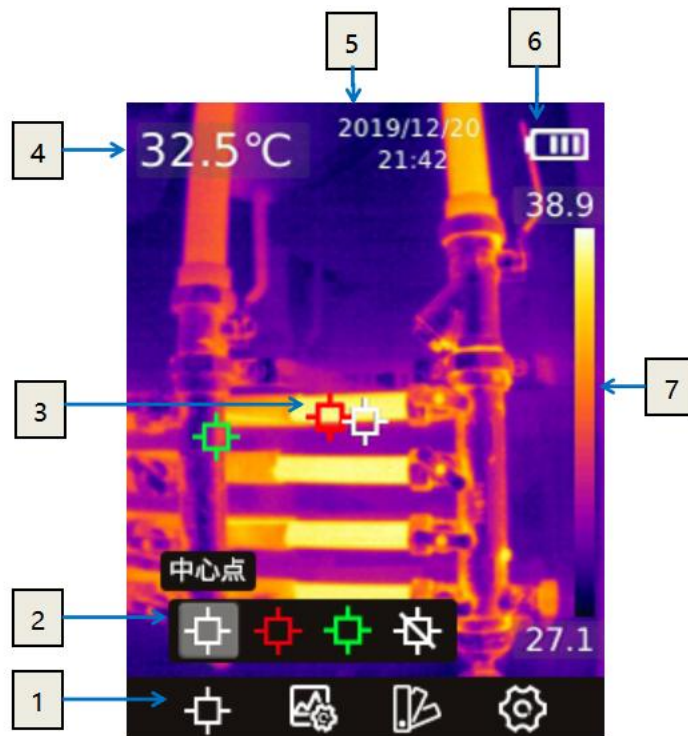

No	Name	Description
1	Main toolbar	measurement mode, image mode, color palette and settings can be set.
2	Secondary toolbar	detailed options can be set here, such as selecting color palette.
3	Temperature measurement spot	it is divided into center spot, Max. temperature / Min. temperature spot tracing, closing thermographic spot, custom thermographic spot.
4	Central spot temperature	display the temperature of the central spot
5	Date and time	display date and time
6	Battery Capacity	display the remaining battery capacity
7	Temperature range	display the temperature range in the current image

Table 8.1 Interface Introduction

9. Operating Instructions

9.1 Power On & Off

1. In the shutdown status, long press the power button to turn on.
2. In the power-on status, long press the power button to turn off.
3. If the device crashes, you can shut it down by pressing and holding the power button.

9.2 Saving Images

1. In the auto save mode, click the trigger to save the picture automatically.
2. In the manual mode, click the trigger, then manually save images or cancel saving.
3. The 16G SD card can save about 70, 000 images.

Note: the auto/manual mode can be switched in the "Settings - auto save" option.



9.3 View / Delete Pictures

When you take and save a picture, it will be stored in SD card, you can view the saved image at any time as follows:

1. Click the View Memory button to enter the library.
2. Use the direction button to select the picture you want to view.
3. Press confirm button to view the picture in full screen.
4. Click the View Memory button or the return button continuously to return to the thermal imaging interface.



9.4 Center Spot Temperature Measurement

You can use point temperature measurement for temperature measurement. The measurement results will be displayed in the upper left corner of the screen, see Section 3.4

1. In the thermal imaging interface, press the center button to display the main toolbar
2. Select the measurement  icon on the toolbar, and press the center button to bring up the secondary toolbar
3. Select "Center Point"  icon on the secondary menu, and press the center button to enable the Center point temperature measurement (on by default), the temperature of the center point will be displayed in the upper left corner of the screen

9.5 Cold/Hot Spot Tracing

You can turn on cold point / hot spot tracking to identify the lowest/highest temperature on the screen by checking the moving cursor:

1. In the thermal imaging interface, click center button to display the main toolbar.
2. Select the measurement  icon on the toolbar, and press the center button to bring up the secondary toolbar.
3. Select “High Temperature”  or “Low Temperature”  icon on the secondary menu, and press the confirm button to enable tracking of high/low temperature point.

9.6 User-defined Spot Measurement

1. In the thermal imaging interface, click center button to display the main toolbar.
2. Select the measurement  icon on the toolbar, and press the center button to bring up the secondary toolbar.
3. In the toolbar, select the "User-defined Spot 1" option. The spot can be moved by the navigation key in the thermal imaging interface. Click the center button to confirm the placement, and the return button to cancel the placement. Select the "User-defined Spot 1" again to turn off the spot display. "User-defined Spot 2" and "User-defined Spot 3" can be set in the same way.

9.7 Image Mode

9.7.1 Imaging Mode Introduction

- Thermal image: Infrared images only

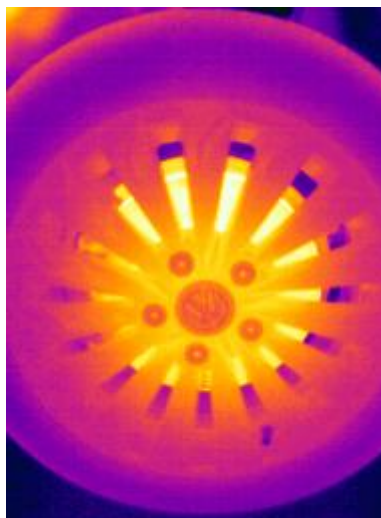

- Fusion: Fusion of infrared image and visual image in a certain scale. In the main interface, you can use the left and right navigation keys to adjust the fusion ratio of infrared and visible light.

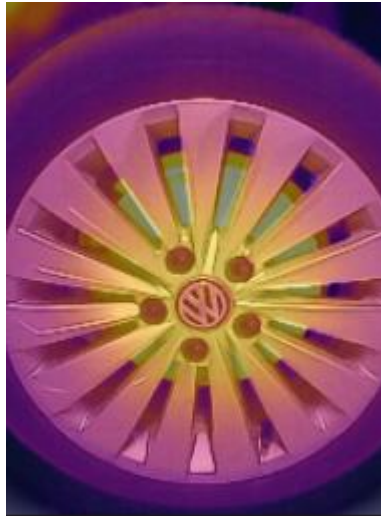

- PIP(Picture in Picture): Thermal image is overlaid on the center of visual camera image.

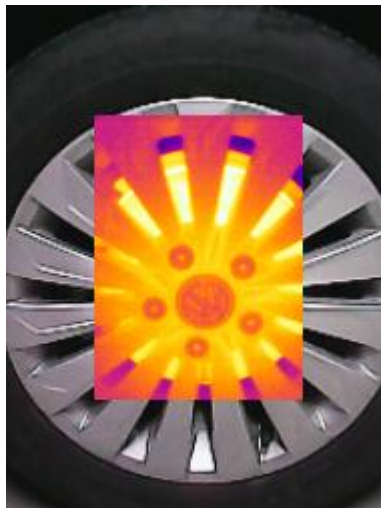

- Digital Camera: Visual camera image only



Note: In order to achieve better overlay image effect, when using the picture in picture, and thermal fusion modes, you need to set the alignment distance, which is the approximate distance from the thermal camera to the target. In picture in picture / thermal fusion / digital camera mode, please make sure that the thermal image displayed on the screen is aligned with the target.

9.7.2 Steps of Changing Image Modes

1. In the thermal imaging interface, press the center button to display the main toolbar
2. select the “Image Mode” icon on the toolbar , and press the center button to bring up the secondary toolbar
3. Select the image mode you need on the secondary toolbar and press the confirm button to switch into the selected image mode.

9.7.3 Color Palettes

You can change the color palette to distinguish temperature difference on the thermal camera. A appropriate color palette can help you analyze images more easily.

1. In the thermal imaging interface, press the center button to display the main toolbar
2. Select the “Color Palette”  icon on the toolbar , and press the center button to bring up the secondary toolbar
3. You can select a new palette and press the center button to switch into the selected palette.

9.8 Shutter Correction

9.8.1 Shutter Correction Introduction

Shutter correction is used to compensate for the non-uniformity of the detector pixels or the non-uniformity caused by other optical interference. When the picture effect is poor, you can perform shutter correction, which is common in situations where the ambient temperature changes rapidly.

9.8.2 Shutter Correction Operation

In the imaging interface, click the return button to perform a non-uniformity correction. During shutter correction, the screen will freeze for a short time, which is normal.

10.Settings

10.1 Measurement Parameters

10.1.1 Setting Emissivity

In order to get more accurate measurement results, you need to set the emissivity according to the target to be measured before each measurement, instead of using the default configuration. Emissivity refers to the ratio of the radiation ability of an object to that of a blackbody at the same temperature, which is relative to the reflectivity of the object. The lower the emissivity, the higher the percentage of energy reflected, and the higher the emissivity, the lower the percentage of energy reflected. For example, human skin emissivity is 0.98 and printed circuit board emissivity is 0.91. For more emissivity information, you can refer to the quick start guide in the package or inquire from other ways.

Emissivity Setting

1. In the thermal imaging interface, press the center button to display the main toolbar
2. select the "Settings"  icon on the toolbar, and press the center button to enter the settings menu.

10.1.2 Setting Ambient Temperature

1. In the thermal imaging interface, press the center button to display the main toolbar
2. Select the "Settings"  icon on the toolbar, and press the center button to enter the settings menu.
3. Select "measurement parameters" in the list, press the confirm key, and then select "ambient temperature" to set ambient temperature.

10.1.3 Setting Distance

Different distances will have different effects on the measurement results. For accurate temperature measurement, the distance information of the object is necessary for compensating for the result.

1. In the thermal imaging interface, click the OK button, and the main menu toolbar will be displayed.
2. In the toolbar, select the "Settings" option and click the OK button to enter "Settings".
3. Select "measurement" in the list, click the confirm button, and then select "distance" to set the distance.

10.2 Temperature Measurement Mode

The temperature measurement mode: HIGH, LOW and AUTO. Users can choose different temperature measurement ranges to ensure temperature measurement accuracy according to the application conditions.

10.3 High/Low Temperature Alarm

The camera supports the high and low temperature alarm function. The user can set the high and low temperature alarm threshold. The alarm function can be turned on or off by setting the "on" and "off" options. After the high and low temperature alarm is triggered, a prompt icon will appear on the screen. If the "LED alarm" option is turned on, the LED light will flash promptly when an alarm occurs.

For alarm snapshot function, you can set the alarm snapshot time interval and the number of photos taken. Turn on this function, after triggering the high and low temperature alarm, it will take pictures according to the set time interval. When the set number of pictures is reached, the camera will stop taking photos and this function will be turned off automatically. It needs to be turned on again when it is used.

10.4 Photo-taking Settings

10.4.1 Automatically Save Photos

Turn on this function, the picture will be automatically saved after taking a picture.

10.4.2 Time-lapsed Photo

The camera supports the function of taking pictures at regular intervals, and users can independently set the time interval and number of pictures taken. If this function is turned on, photos will be taken at the set time interval. After the set number of photos is reached, the camera will stop taking photos and this function will be automatically turned off.

10.5 Temperature Unit

The camera supports temperature displays in degrees Celsius, Fahrenheit, and Kelvin.

10.6 Wi-Fi Settings

The hotspot function is available for some models, it can achieve wireless projection via connection with client software when activated. Refer to the camera display for user name and password.

10.7 Auto Power-Off

The camera supports auto power-off, four options: 5 mins, 10mins, 20mins, off.

10.8 System Settings

In system settings, you can view the relevant information of this camera, and perform operations such as restoring factory default settings and formatting the SD card. In the "USB Mode" option, the default is U-disk mode, and the computer can directly access the SD card in the device through the USB cable. the option of "USB Camera" is provided in some models, which can synchronize the picture in the camera to the PC software for real-time display and analysis.

11.Application Scenarios

11.1 Warehouse Detecting

With the help of C series handheld thermal camera, warehouse inspection personnel can quickly find abnormal high temperature objects in the warehouse, and take corresponding measures to eliminate potential safety hazards timely.



Warehouse Detecting

11.2 Detecting of Power Distribution Cabinet

The temperature distribution of power distribution equipment can directly reflect the running status of the equipment. Improper contact or damage may cause abnormal high temperature. The inspection personnel can detect anomalies in time to ensure the safety of power distribution equipment.



Detecting of Power Distribution Cabinet

11.3 Detecting of Heating Wire of Rear Car Window

The heating wire on the rear car window can defrost and defog to ensure the safety of driving, especially on rainy and snowy days. The whole on-off condition of the heating wire can not be seen through visible light. The whole heating wire can be quickly detected by C series handheld thermal camera to analyze whether the heating wire is broken.

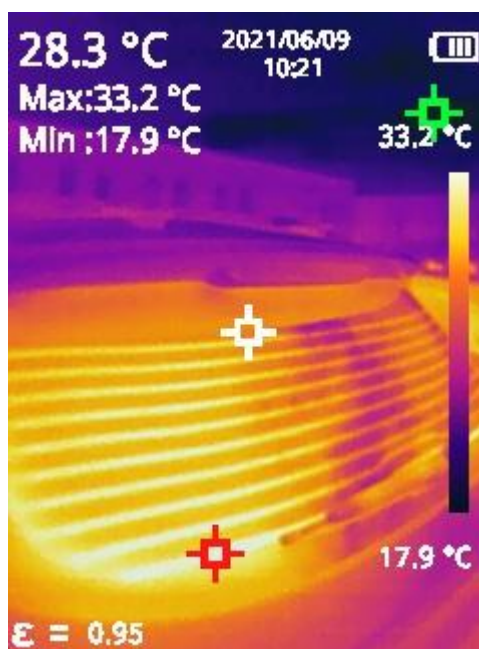

Detecting of Heating Wire of Car Window

11.4 HVAC Detecting

C series handheld thermal camera can help HVAC engineers to fully capture the temperature distribution of the measured pipeline, quickly find abnormal points, make accurate judgment and positioning, effectively avoid the economic loss caused by disassembly, and at the same time improve service quality and enhance customer satisfaction.

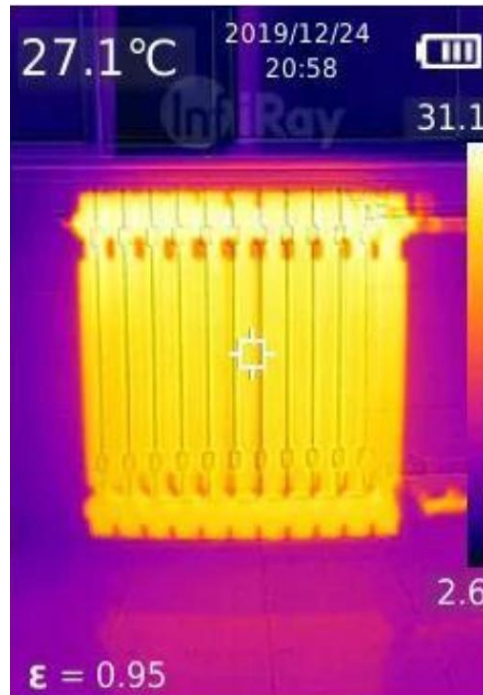

HVAC Detecting

12. Structural Drawing

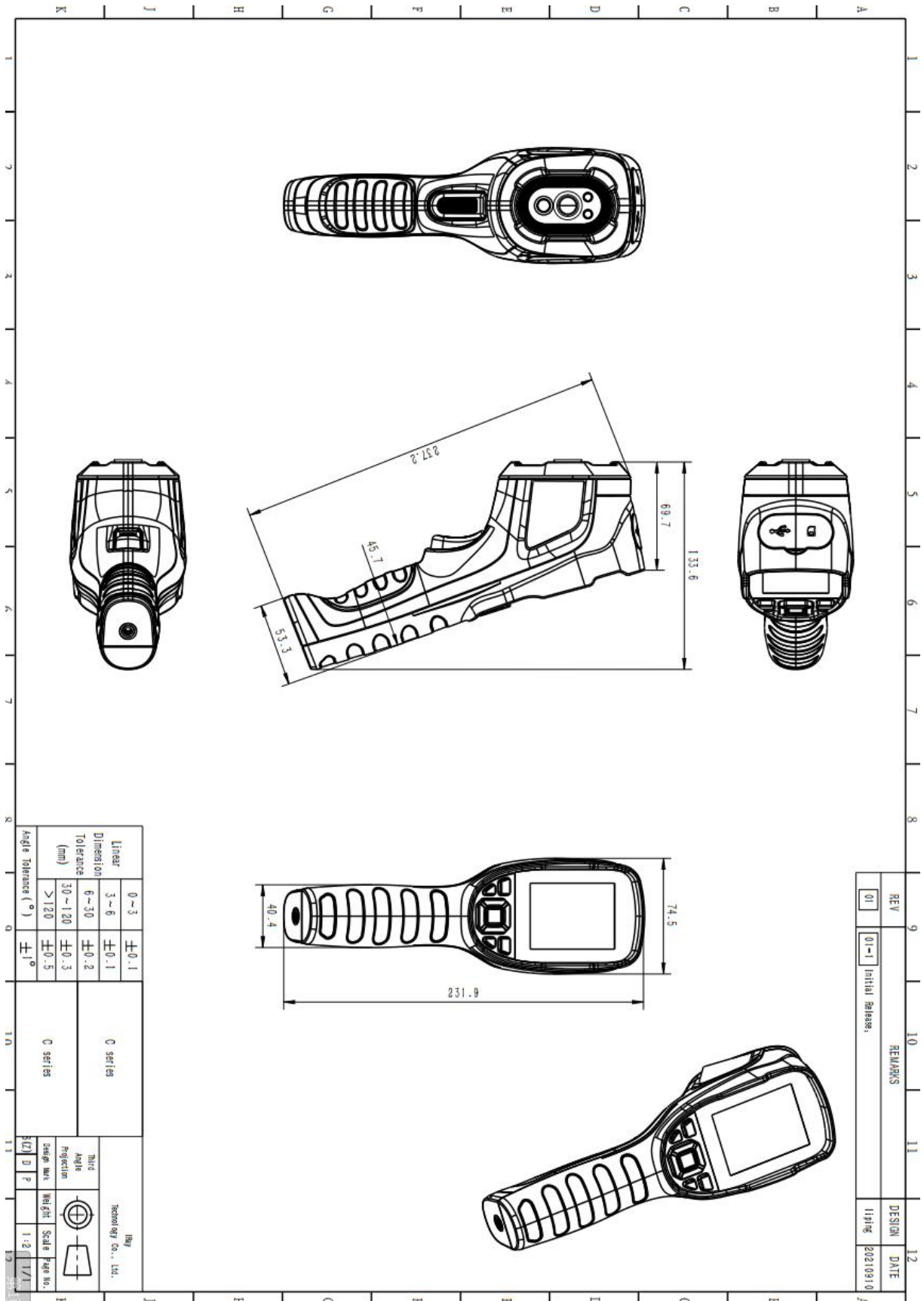

13.FAQ

1. There is a big difference between the measured temperature and the actual temperature.

Solutions: set the correct emissivity; the actual distance should be consistent with the set distance.

2. The client software can not be connected and the real-time image can not be previewed.

Possible causes: the USB mode has not been successfully set.

Solutions: change the USB mode to USB camera mode.

3. The measured temperature is abnormal if the target temperature is above 150℃.

Possible causes: the temperature measurement mode has not been changed.

Solutions: choose the corresponding temperature measurement mode for different targets.

4. The camera will shut down automatically if it is not operated for a long time.

Possible causes: the auto power-off is enabled.

Solutions: you can choose 5min, 10min, 20min and auto power-off disabled according to your actual need.

14.Cleaning Thermal Camera

14.1 Cleaning Camera Housing, Cables and Other Items

Camera Housing, Cables and Other Items	
Liquids	One of the following liquids can be used. 1.Warm water 2.A Weak detergent solution
Cleaning Tools	A soft cloth
Cleaning Procedure	Please follow this procedure: 1.Soak a soft cloth in the liquid. 2.Twist the cloth to remove excess liquid. 3.Clean the camera parts with the cloth.

**Caution**

Do not apply solvents or similar liquids to the camera, the cables, or other items. This can cause damage.

14.2 Cleaning Infrared Lens

Cleaning Infrared Lens	
Liquids	<p>One of the following liquids can be used.</p> <ol style="list-style-type: none"> 1. Commercial lens cleaning liquid with more than 30% is opropyl alcohol. 2. 96% ethyl alcohol(C_2H_5OH).
Cleaning Tools	cotton wool
Cleaning Procedure	<p>Please follow this procedure:</p> <ol style="list-style-type: none"> 1. Soak the cotton wool in the liquid. 2. Twist the cotton wool to remove the excess liquid. 3. Clean the lens one time only and discard the cotton wool.

**CAUTION**

Do not clean the infrared lens too vigorously. This can damage the anti-reflective coating.

Worth comes from Service

24h Hotline:

400-998-3088

Technical Support

Hotline:

400-883-0800

Customized Services