

HAKKO FX-100

SOLDERING STATION

Soldering Station

Instruction Manual

Thank you for purchasing the HAKKO FX-100 Soldering Station.
Please read this manual before operating the HAKKO FX-100.
Keep this manual readily accessible for reference.

1. PACKING LIST AND PART NAMES Please check to make sure that all items listed below are included in the package.

| | | | |
|--------------------------------------|---|--------------------------|---|
| HAKKO FX-100 soldering station | 1 | Heat resistant pad | 1 |
| HAKKO FX-1001 soldering iron | 1 | Iron holder | 1 |
| Sleeve (Green) | 1 | Power cord | 1 |
| Sleeve (Gray) | 1 | Instruction manual | 1 |
| Cleaning wire | 1 | | |

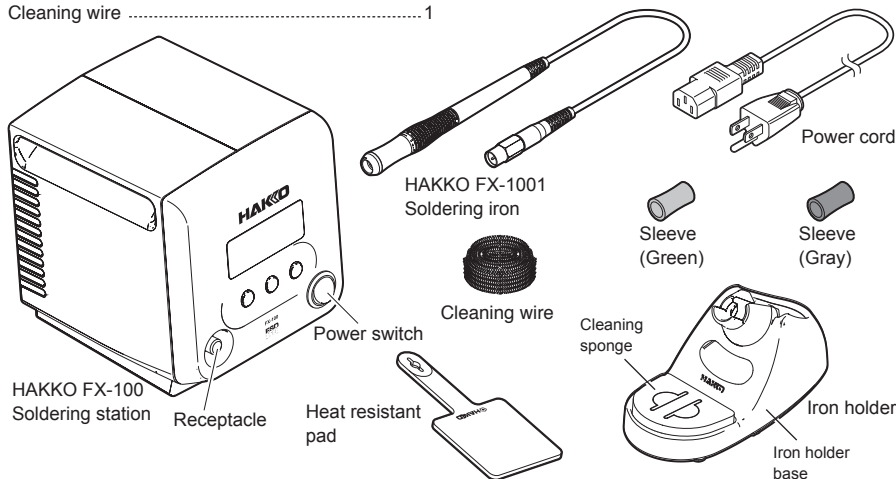

2. COMPATIBLE MODELS

Use this product with the following models.

- FX-1001 (Soldering Iron) T31 series (tip for FX-1001)
- FX-1002 (Micro Soldering Iron) T35 series (tip for FX-1002)
- FX-1003 (Micro Tweezers) T38 series (tip for FX-1003)

3. SPECIFICATIONS

| | |
|-----------------------|-------------------------------|
| Power consumption | 28 W (85 W) |
| Tip series / | T31-01 Series / 450°C (840°F) |
| Tip temperature | T31-02 Series / 400°C (750°F) |
| | T31-03 Series / 350°C (660°F) |
| Temperature stability | ±1.1°C (±2.0°F) |

● Station

| | |
|------------------|---|
| Output power | 50 W |
| Output frequency | 13.56 MHz |
| Dimensions | 127 (W) × 150 (H) × 167 (D) mm (5.0 × 5.9 × 6.6 in.) |
| Weight | 3 kg (6.6 lb.) |

● HAKKO FX-1001 soldering iron

| | |
|-------------------------|-------------------------------------|
| Length of cord | 1.3 m (4.3 ft.) |
| Total Length (w/o cord) | 190 mm (7.5 in.) with T31-02D24 tip |
| Weight (w/o cord) | 31 g (0.07 lb.) with T31-02D24 tip |

NOTE:

This product is protected against electrostatic discharge.

* Specifications and design are subject to change without notice.

※各言語（日本語、英語、中国語、フランス語、ドイツ語、韓国語）の取扱説明書は以下のURL、HAKKO Document Portalからダウンロードしてご覧いただけます。
(商品によっては設定の無い言語がありますが、ご了承ください。)
* 各国語言（日語、英語、中文、法語、德語、韓語）的使用說明書可以通過以下网站的HAKKO Document Portal 下載參閱。
(有一部分的产品沒有設定外語對應、請見諒)
* Instruction manual in the language of Japanese, English, Chinese, French, German, and Korean can be downloaded from the HAKKO Document Portal.
(Please note that some languages may not be available depending on the product.)

➡ <https://doc.hakko.com>

⚠ CAUTION

This product includes such features as electrically conductive plastic parts and grounding of the handpiece and station as measures to protect the device to be soldered from the effects of static electricity. Be sure to observe the following instructions:

1. The handle and other plastic parts are not insulators, they are conductors. When replacing parts or repairing, take sufficient care not to expose live electrical parts or damage insulation materials.
2. Be sure to ground the unit during use.

4. WARNINGS, CAUTIONS AND NOTES

Warnings, cautions and notes are placed at critical points in this manual to direct the operator's attention to significant items. They are defined as follows:

⚠ WARNING: Failure to comply with a WARNING may result in serious injury or death.

⚠ CAUTION : Failure to comply with a CAUTION may result in injury to the operator, or damage to the items involved. Two examples are given below.

NOTE : A NOTE indicates a procedure or point that is important to the process being described.

⚠ WARNING

When power is ON, the tip will be hot. To avoid injury or damage to personnel and items in the work area, observe the following:

- Do not touch the tip or the metal parts near the tip.
- Do not allow the tip to come close to, or touch, flammable materials.
- Inform others in the area that the unit is hot and should not be touched.
- Turn the power off when not in use, or left unattended.
- Turn the power off when changing parts or storing the HAKKO FX-100.
- The unit is for a counter or workbench use only.
- This appliance can be used by children aged from 8 years and above and persons with reduced physical, sensory or mental capabilities or lack of experience and knowledge if they have been given supervision or instruction concerning use of the appliance in safe way and understand the hazards involved.
- Children shall not play with the appliance.
- Cleaning and user maintenance shall not be made by children without supervision.

To prevent accidents or damage to the HAKKO FX-100, be sure to observe the following:

⚠ CAUTION

- Do not use the HAKKO FX-100 for applications other than soldering.
- Do not allow the HAKKO FX-100 to become wet, or use it when hands are wet.
- Do not modify the HAKKO FX-100.
- Use only genuine HAKKO replacement parts.
- Be sure to hold the plug when inserting or removing the iron cord.
- Do not strike the iron against hard objects to remove excess solder. This will damage the iron.
- Be sure the work area is well ventilated. Soldering produces smoke.
- While using the HAKKO FX-100, don't do anything which may cause bodily harm or physical damage.

5. INITIAL SETUP

A. Iron holder

- This product includes two methods for cleaning the tip: a wire tip cleaner, and a sponge. Please be sure to soak the sponge in water before using.
1. Set the iron holder.
 2. Put the small cleaning sponge in one of the five holes in the iron holder base.
 3. Add water to the iron holder base. The small sponge will keep the large sponge moist through capillary action.
 4. Wet the large sponge, squeeze it dry and put it on the iron holder base.

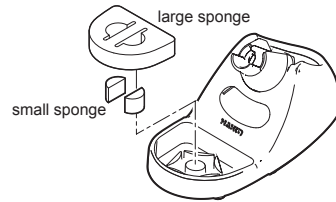

CAUTION
Using the sponge without water may damage the tips.

*When using a Cleaning Wire

Place it in the iron holder as shown on the right. See "2.Using a Cleaning Wire" in section "7. MAINTENANCE"



B. Handpiece cord assembly

1. Pass the iron cord through the hole in the heat resistant pad.
2. Hold the head part of the tip (not included) with the heat resistant pad and insert the tip into the handpiece. Push until the tip stops.

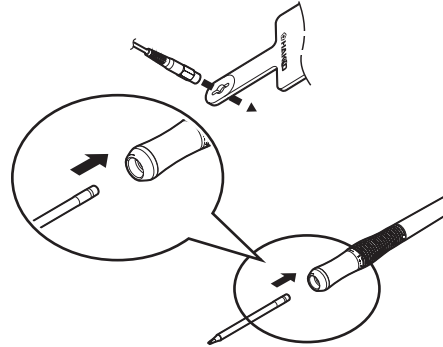

C. Station

CAUTION
Be sure the power switch is OFF before connecting or disconnecting the soldering iron cord. Failure to do so may result in damage to the circuit board.

1. Insert the power cord into the receptacle at the back of the station.

CAUTION
Do not twist connector cable when inserting, as it may cause wire breakage.

2. Insert the connection cable plug into the receptacle at the front of the station, and turn it in a clockwise direction until it stops.

3. Set the iron in the iron holder.

4. Plug the power cord into a grounded wall socket.

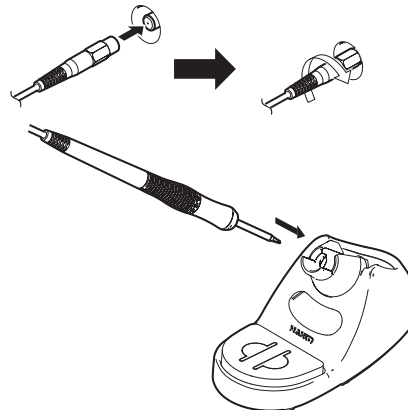

CAUTION
The HAKKO FX-100 is protected against electrostatic discharge and must be grounded for full efficiency.

5. INITIAL SETUP (cont'd)

■ How to replace the sleeve

1. Turn the sleeve assembly counterclockwise and remove it from the handle.



2. Remove the sleeve as shown in the diagram below.

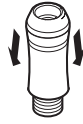

NOTE:

A small o-ring is placed inside the sleeve assembly and may fall out when you remove the sleeve assembly. Be sure not to lose this o-ring.

3. Turn the sleeve counterclockwise just like loosening a screw and remove it.

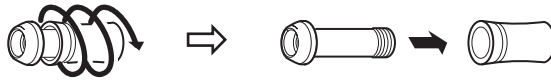

4. Insert the new sleeve.

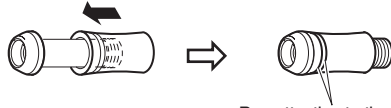

Pay attention to the direction of the sleeve.

5. Before you re-attach the sleeve assembly to the handle, be sure the small o-ring is in place and seated properly in the sleeve assembly.

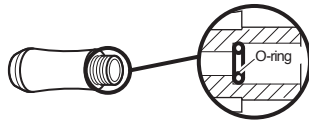

6. OPERATION

● Operation

1. Turn ON the power switch.
2. The screen will switch in order of product number indication → greeting → home screen.
3. When the home screen is displayed, the MODE status is indicated on the left and output graph at the center. The graph starts rising as the iron tip temperature increases. The graph starts falling as the iron tip approaches stable temperature, reaching the minimum when the stable temperature is achieved. Start soldering after the stable temperature is reached.

Controls and displays

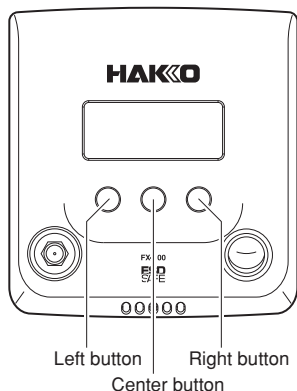

HAKKO FX-100 has 3 operation buttons. The operation executed by each button varies depending on what is on the display screen. The operation for each button is indicated at the bottom of the screen. Select the button according to the indication.

By pressing certain buttons from the home screen, the display will change, revealing the button labels and waiting for your selection.

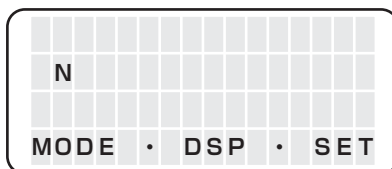

Left button MODE
Center button DSP (Display)
Right button SET (Parameters)

If no button is pressed, it will go back to the home screen.

Example) MODE screen

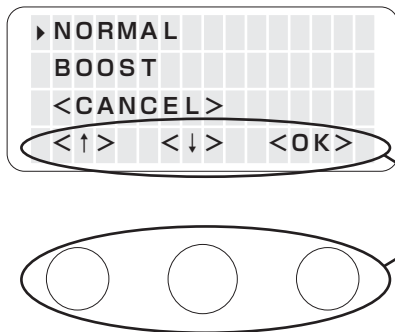

Operate the machine using these buttons that are placed in the order of the buttons displayed on the screen.

Display item and initial value of MODE / DSP screen are as follows.

| Display | Display item | Initial value |
|---------|---|--|
| MODE | NORMAL / BOOST | NORMAL |
| DSP | SHOW PROFILE / SHOW TIP LOADS / SHOW TIP TIME / SELECT PROFILE / TIP TYPE | |
| | SHOW PROFILE | Display in the set profile |
| | SHOW TIP LOADS | Display in the soldering count |
| | SHOW TIP TIME | Display in the cumulative running time on the iron tip |
| | SELECT PROFILE | No.1 / No.2 |
| | TIP TYPE | AUTO DETECT / MANUAL SET / OFF |
| | MANUAL SET* | <01> / <02> / <03> |

* Displayed only when "MANUAL SET" is selected.

• When MODE is pressed

The mode can be changed to NORMAL mode or BOOST mode.

By changing the mode to BOOST, the performance of the station is increased and the tip temperature rises slightly.

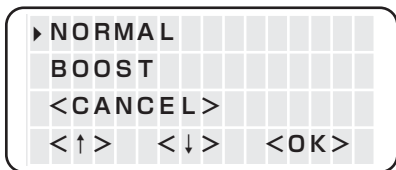

Move the cursor by pressing the <↑> or <↓> button to select NORMAL or BOOST. After selecting, press <OK>.

Display in the NORMAL mode

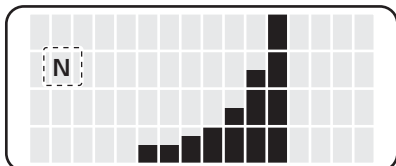

Display in the BOOST mode

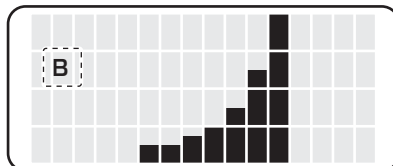

6. OPERATION (cont'd)

- When DSP (Display) is pressed
The selected information will be displayed on the screen.

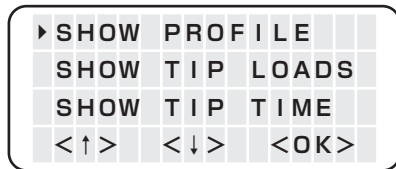

The cursor moves by pressing the <↑> or <↓> button. The following items are displayed in order.

- SHOW PROFILE
- SHOW TIP LOADS
- SHOW TIP TIME
- SELECT PROFILE
- TIP TYPE
- <CANCEL>

SHOW PROFILE

The set profile information (Station, User, and Solder) is displayed.

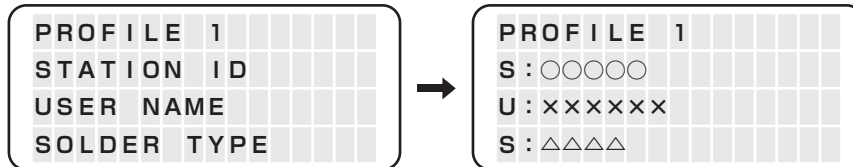

SHOW TIP LOADS

The soldering count is displayed. By selecting RESET and then OK, the count is reset to 0. To escape without resetting, select CANCEL.

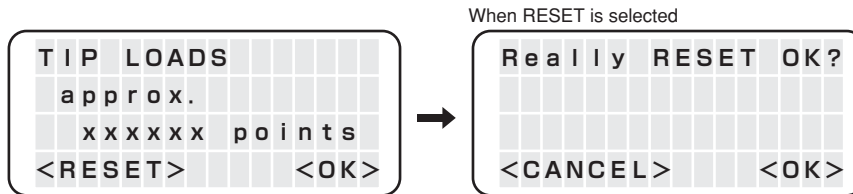

⚠ CAUTION

The solder count is an approximate number. The number is sometimes counted when temperature change occurs in the tip other than soldering.

SHOW TIP TIME

The cumulative running time on the iron tip is displayed. * Not including shut-off period. By selecting RESET and then OK, the period is reset to 0. To escape without resetting, select CANCEL.

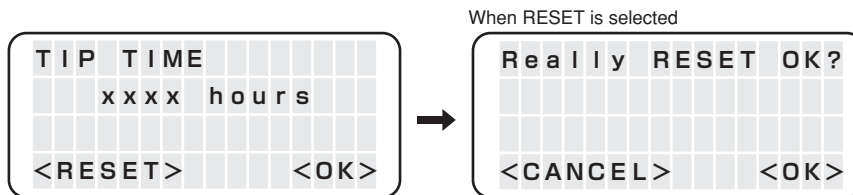

NOTE:

If you select RESET in the TIP LOADS screen or the TIP TIME screen, you need to enter the password if password lock is set.

SELECT PROFILE

The profile information to be displayed is selected here. Profile information No.1 or No.2 can be selected.

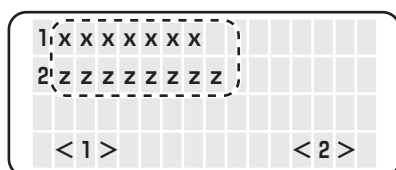

NOTE:

If any user name is set, it is displayed in this step.

6. OPERATION (cont'd)

TIP TYPE

Once [MANUAL SET] is selected, a screen resembling the one on the bottom right is displayed. Choose <01>, <02>, or <03> depending on the temperature of the soldering iron tip being used.

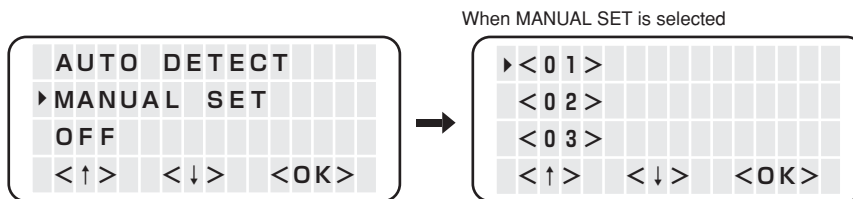

Display in the MANUAL SET mode (when T31-01 is selected)

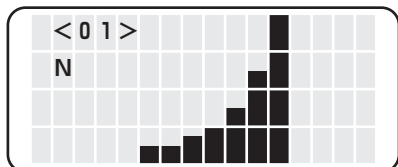

• When AUTO DETECT is selected

When AUTO DETECT is selected, tip type is automatically detected under the following conditions.

- Automatic detection will only function for the T31-01 and T31-02 series.
- The tip must be cold and placed on the soldering iron stand.

When both condition is satisfied, "01" or "02" is detected when the power is turned ON.

Display in the AUTO DETECT mode (when T31-01 is selected)

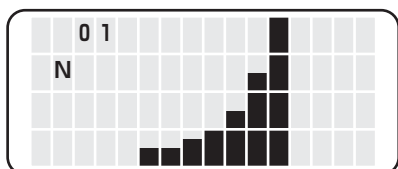

NOTE:

Even when tip other than T31-01 or T31-02 is used, it will display either "01" or "02" with the AUTO DETECT function.

7. PARAMETER SETTING

• When SET is pressed

Various settings can be changed. After changing the setting, setting change is reflected by selecting SAVE → OK. To escape without setting change, select CANCEL. If you are going to set a password lock, you are prompted to enter the password before entering SET screen.

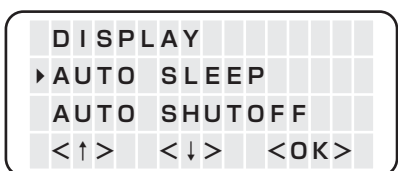

The cursor moves by pressing the <↑> or <↓> button. The following items are displayed in order.

- DISPLAY
- AUTO SLEEP
- AUTO SHUTOFF
- PASSWORD LOCK
- PROFILE
- ALERT TIME
- <SAVE>
- <CANCEL>

Display item and initial value of SET screen are as follows.

| Display | Display item | Initial value |
|---------------|---|---------------|
| SET | DISPLAY / AUTO SLEEP / AUTO SHUT OFF / PASSWORD LOCK / PROFILE / ALERT TIME | |
| DISPLAY | NORMAL / EXPAND / OFF | NORMAL |
| AUTO SLEEP | 00 (OFF) / 01 - 29 min | 06 min |
| AUTO SHUT OFF | OFF / 30 min / 60 min | 30 min |
| PASSWORD LOCK | ON / OFF | OFF |
| PASSWORD* | "A - Z" Select three letters | - |
| PROFILE | STATION ID / PROFILE 1 / PROFILE 2 | - |
| STATION ID | "A - Z", "0 - 9", ".", "-", and space. You can enter up to 14 letters. | - |
| PROFILE 1 (2) | USER NAME / SOLDER TYPE | - |
| USER NAME | "A - Z", "0 - 9", ".", "-", and space. You can enter up to 14 letters. | - |
| SOLDER TYPE | "A - Z", "0 - 9", ".", "-", and space. You can enter up to 14 letters. | - |
| ALERT TIME** | 0 - 9999 hours | 0 |

* Displayed only when PASSWORD LOCK "ON" is selected.

** CHG TIP will not be displayed when ALERT TIME is set to "0". (See the "ALERT TIME")

7. PARAMETER SETTING (cont'd)

DISPLAY

The fashion in which the output graph is displayed can be changed.

NORMAL: Histogram (rolling bar graph), EXPAND: Horizontal expanding graph, OFF: No display

DISPLAY screen

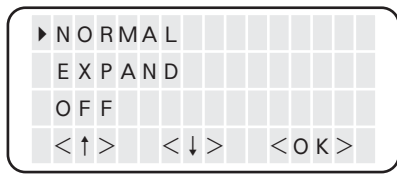

When NORMAL is selected

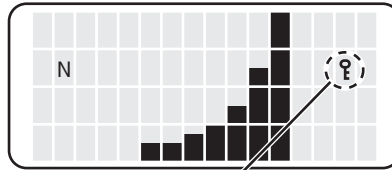

When EXPAND is selected

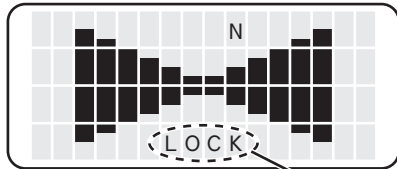

When OFF is selected

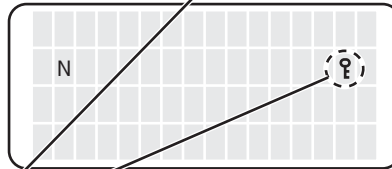

Displayed when password lock is set

AUTO SLEEP

The automatic sleep period can be set up. Sleep function is canceled by removing the solder iron from the holder or pressing one of the 3 buttons.

Setting AUTO SLEEP

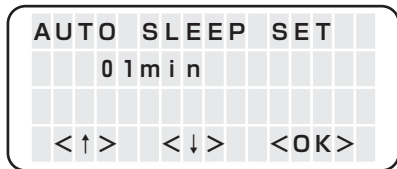

In the AUTO SLEEP mode, you can set the sleep time between 01 to 29 minutes. When 00 is set, the sleep function is OFF

AUTO SHUTOFF

The time to automatically turn off the soldering station can be set up. Electricity is stopped automatically when the solder iron is not used for the set period of time. SHUTOFF function is canceled by pressing one of the 3 buttons.

Setting AUTO SHUTOFF

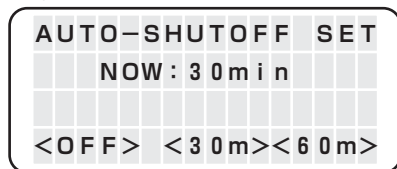

When the SHUT OFF time is set, the power supply stops when the soldering iron is not used for the set period of time even though the soldering iron is not placed on the stand.

PASSWORD LOCK

The setting can be changed so that a password input is required every time a parameter is changed or a count is reset. A 3-letter password comprising of letters A to Z is set up.

Setting PASSWORD LOCK

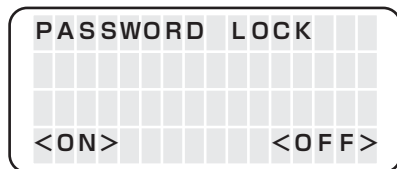

PASSWORD input screen (When ON is selected)

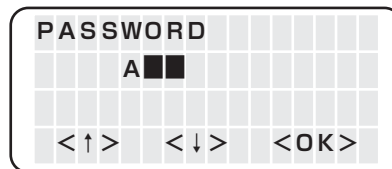

7. PARAMETER SETTING (cont'd)

PROFILE

The profile information can be set up.

STATION ID: Station name, Asset ID, etc., PROFILE1,2: User name and solder information.

PROFILE screen

```
▶ STATION ID
  PROFILE 1
  PROFILE 2
<↑> <↓> <OK>
```

When STATION ID is selected

```
STATION ID
{
<↑> <↓> <OK>
```



When PROFILE1 (2) is selected

```
▶ USER NAME
  SOLDER TYPE
<CANCEL>
<↑> <↓> <OK>
```

When USER NAME is selected

```
PROF. 1 USER
{
<↑> <↓> <OK>
```

You can make your name and ID from "A-Z", "0-9", ".", "-", and space. You can enter up to 14 letters. This is blank in the initial setting.

When SOLDER TYPE is selected

```
PROF. 1 SOLDER
{
<↑> <↓> <OK>
```

ALERT TIME

"CHG TIP" is displayed on the home screen when the iron tip cumulative running time reaches the set period. To clear this display, you need to change the tip and reset the TIP TIME from the DSP menu. (See 5. How to Use, "SHOW TIP TIME".)

Setting ALERT TIME

```
ALERT TIME
  xxx hours
<↑> <↓> <OK>
```

Display in the "CHG TIP"

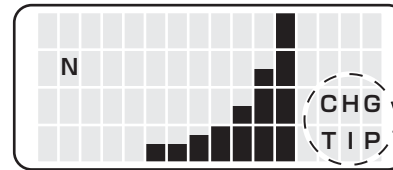

8. MAINTENANCE

Performing proper and periodic maintenance extends product life. Efficient soldering depends upon the temperature, quality and quantity of the solder and flux. Apply the following service procedure as dictated by the conditions of usage.

⚠ WARNING

Since the soldering iron can reach a very high temperature, please work carefully. Except the case especially indicated, always turn the power switch OFF and disconnect the power plug before performing any maintenance procedure.

● Tip Maintenance

1. When the temperature stabilizes, clean the tip with the cleaning sponge and check the condition of the tip.
2. If the solder plated part of the tip is covered with black oxide, apply fresh solder containing flux, and clean the tip again. Repeat until all the oxide is removed, then coat the tip with fresh solder.
3. If the tip is deformed or heavily eroded, replace it with a new one.

⚠ CAUTION

Do not file the tip in an attempt to remove the black oxide.

■ Cleaning the tip using the iron holder

1. Using the cleaning sponge

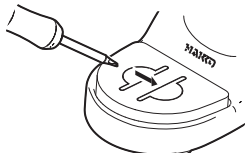

Use the cleaning sponge that comes with the product to clean the tip. It offers wide-ranging uses, from simple removal of excess solder to complete elimination of matter occurring as a result of oxidization.

2. Using the cleaning wire

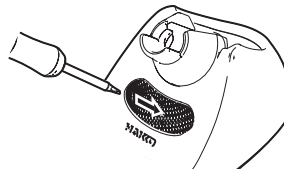

Material that is not removed easily with the cleaning sponge can likely be removed using the cleaning wire.

■ Replacing the fuse

1. Unplug the power cord from the power receptacle.
2. Remove the fuse holder.
3. Replace the fuse.
4. Put the fuse holder back in place.

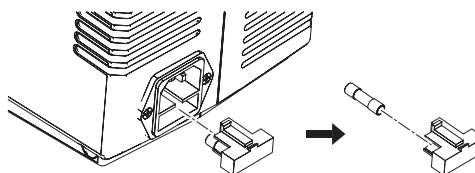

9. TROUBLE SHOOTING GUIDE

⚠ WARNING

Before checking the inside of the HAKKO FX-100 or replacing parts, be sure to disconnect the power plug. Failure to do so may result in electric shock.

- The solder iron does not operate even when the power switch is turned ON.

CHECK : Is the power supply cable or connection plug disconnected?

ACTION : Connect it tightly.

CHECK : Is the fuse blown?

ACTION : Replace the fuse. If the fuse blows again, please send the entire product back to us for repair.

- Grip Error is displayed.

ACTION : Check that the soldering iron or the iron tip is connected. If the error is displayed again even when it is connected, the soldering iron or the iron tip may be damaged.

- Solder does not become wet at the iron tip.

CHECK : Is the tip oxidized?

ACTION : Clean the tip to remove oxidation.

- The tip temperature is too Low.

CHECK : Is the tip oxidized?

ACTION : Clean the tip to remove oxidation.

10. OPTION

The port on the back of the station is used to display heater output on the external device. (not included)

The output displayed on the monitor can be displayed on an external device by connecting the machine to equipment such as an oscilloscope.

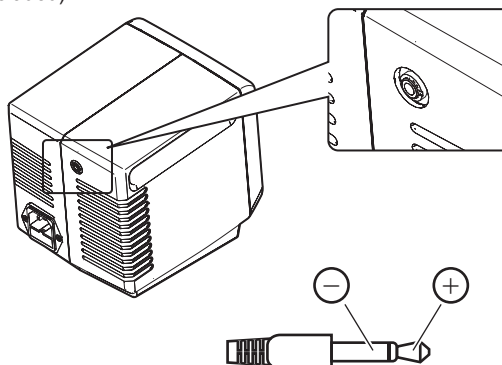

Please purchase in the way of your connection plug (Φ3.5 mono plug).

11. PARTS LIST

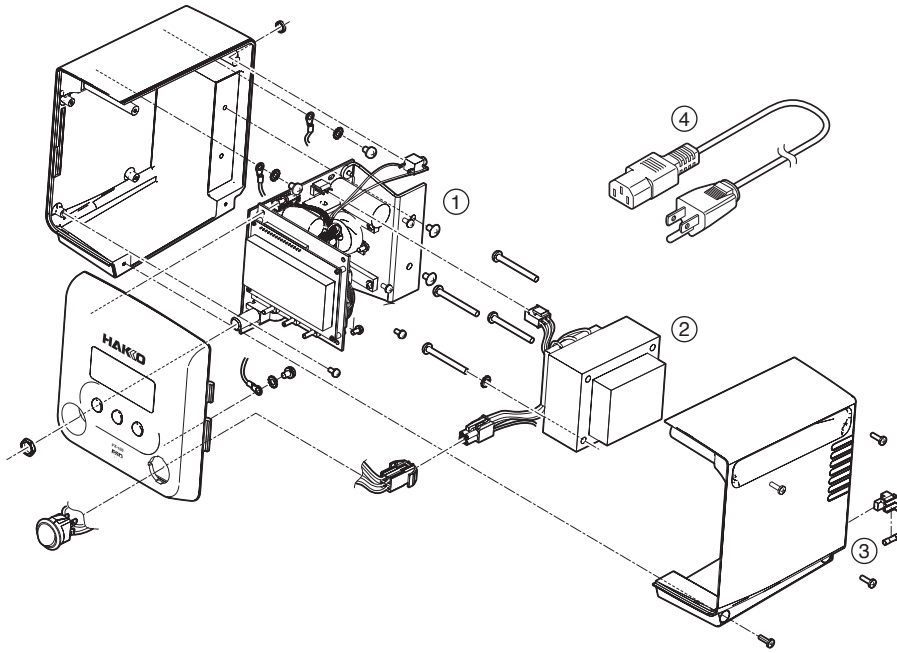

● HAKKO FX-100 Station

| Item No. | Part No. | Part Name | Specifications |
|----------|----------|--------------|----------------|
| ① | B5002 | P.W.B. | |
| ② | B5003 | Transformer | 100 - 110V |
| | B5004 | Transformer | 120V |
| | B5005 | Transformer | 220 - 240V |
| ③ | B2403 | Fuse/250V-2A | 100 - 110V |
| | B3011 | Fuse/250V-2A | 120V |
| | B2987 | Fuse/250V-1A | 220 - 240V |

| Item No. | Part No. | Part Name | Specifications |
|----------|----------|---|------------------|
| ④ | B2419 | Power cord, 3-wire cord & American plug | 120V USA |
| | B2421 | Power cord, 3-wire cord but no plug | |
| | B2422 | Power cord, 3-wire cord & BS plug | India |
| | B2424 | Power cord, 3-wire cord & European plug | 220V KTL 230V CE |
| | B2425 | Power cord, 3-wire cord & BS plug | 230V CE |
| | B2426 | Power cord, 3-wire cord & Australian plug | |
| | B2436 | Power cord, 3-wire cord & Chinese plug | China |
| | B3508 | Power cord, 3-wire cord & American plug (B) | |
| | B3550 | Power cord, 3-wire cord & SI plug | |

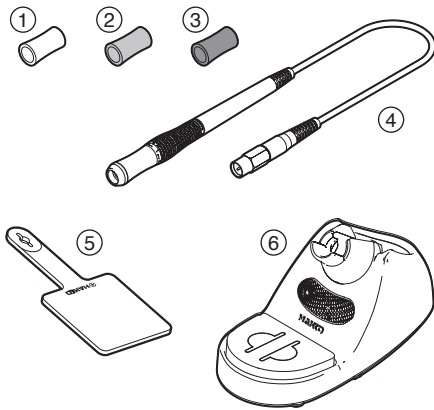

● HAKKO FX-1001

| Item No. | Part No. | Part Name | Specifications |
|----------|------------|--------------------|----------------|
| ① | B5006 | Sleeve / Yellow | |
| ② | B5007 | Sleeve / Green | |
| ③ | B5008 | Sleeve / Gray | |
| ④ | FX1001-81 | HAKKO FX-1001 | |
| ⑤ | B2300 | Heat resistant pad | |
| ⑥ | FH800-81BY | HAKKO FH-800 | |

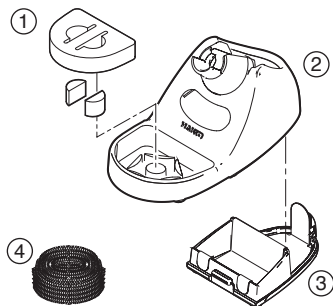

● Iron Holder Parts

| Item No. | Part No. | Part Name | Specifications |
|----------|----------|--------------------------------|-------------------------------------|
| ① | A5038 | Cleaning sponge | |
| ② | B5009 | Iron holder base / Blue-yellow | with rubber foot |
| ③ | B3751 | Bottom plate | with Protective Sheet & rubber foot |
| ④ | A1561 | Cleaning wire | |

● Optional Parts

| Part No. | Part Name | Specifications |
|----------|----------------|----------------|
| B3474 | Rubber cleaner | |



HAKKO CORPORATION

HEAD OFFICE

4-5, Shiokusa 2-chome, Naniwa-ku, Osaka 556-0024 JAPAN
TEL: +81-6-6561-3225 FAX: +81-6-6561-8466
<https://www.hakko.com> E-mail: sales@hakko.com

OVERSEAS AFFILIATES

U.S.A.: AMERICAN HAKKO PRODUCTS, INC.
TEL: (661) 294-0090 FAX: (661) 294-0096
Toll Free (800) 88-HAKKO
<https://www.HakkoUSA.com> E-mail: Support@HakkoUSA.com

HONG KONG: HAKKO DEVELOPMENT CO., LTD.
TEL: 2811-5588 FAX: 2590-0217
<https://www.hakko.com.cn> E-mail: info@hakko.com.hk

SINGAPORE: HAKKO PRODUCTS PTE., LTD.
TEL: 6748-2277 FAX: 6744-0033
<https://www.hakko.com.sg> E-mail: sales@hakko.com.sg

Please access the web address below for other distributors.

<https://www.hakko.com>